



Instructions for Installation, Operation and Maintenance of Type VCP-W Vacuum Circuit Breakers



**WARNING**

IMPROPERLY INSTALLING OR MAINTAINING THESE PRODUCTS CAN RESULT IN DEATH, SERIOUS PERSONAL INJURY, OR PROPERTY DAMAGE.

READ AND UNDERSTAND THESE INSTRUCTIONS BEFORE ATTEMPTING ANY UNPACKING, ASSEMBLY, OPERATION OR MAINTENANCE OF THE CIRCUIT BREAKERS.

INSTALLATION OR MAINTENANCE SHOULD BE ATTEMPTED ONLY BY QUALIFIED PERSONNEL. THIS INSTRUCTION BOOK SHOULD NOT BE CONSIDERED ALL INCLUSIVE REGARDING INSTALLATION OR MAINTENANCE PROCEDURES. IF FURTHER INFORMATION IS REQUIRED, YOU SHOULD CONTACT CUTLER-HAMMER.

**WARNING**

THE CIRCUIT BREAKER ELEMENTS DESCRIBED IN THIS BOOK ARE DESIGNED AND TESTED TO OPERATE WITHIN THEIR NAMEPLATE RATINGS. OPERATION OUTSIDE OF THESE RATINGS MAY CAUSE THE EQUIPMENT TO FAIL, RESULTING IN DEATH, BODILY INJURY AND PROPERTY DAMAGE.

ALL SAFETY CODES, SAFETY STANDARDS AND/OR REGULATIONS AS THEY MAY BE APPLIED TO THIS TYPE OF EQUIPMENT MUST BE STRICTLY ADHERED TO.

THESE CIRCUIT BREAKER ELEMENTS ARE DESIGNED TO BE INSTALLED PURSUANT TO THE AMERICAN NATIONAL STANDARDS INSTITUTE (ANSI). SERIOUS INJURY, INCLUDING DEATH, CAN RESULT FROM FAILURE TO FOLLOW THE PROCEDURES OUTLINED IN THIS MANUAL. THESE CIRCUIT BREAKER ELEMENTS ARE SOLD PURSUANT TO A NON-STANDARD PURCHASING AGREEMENT WHICH LIMITS THE LIABILITY OF THE MANUFACTURER.

All possible contingencies which may arise during installation, operation or maintenance, and all details and variations of this equipment do not purport to be covered by these instructions. If further information is desired by purchaser regarding his particular installation, operation or maintenance of particular equipment, contact a Cutler-Hammer representative.

TABLE OF CONTENTS

	PAGE
SECTION 1 INTRODUCTION	
1-1 Preliminary Comments and Safety Precautions	1
1-1.1 Warranty and Liability Information	1
1-1.2 Safety Precautions	1
1-2 General Information.....	1
1-3 Type VCP-W Vacuum Circuit Breaker Element Ratings (Tables 1.1, 1.2, 1.3 and 1.4).....	3
1-4 Outlines and Dimensions	5
 SECTION 2 SAFE PRACTICES	
2-1 Recommendations	7
 SECTION 3 RECEIVING, HANDLING AND STORAGE	
3-1 General	8
3-2 Receiving.....	8
3-3 Handling	8
3-4 Storage	8
3-5 Tools and Accessories	9
3-6 Type VCP-W Vacuum Circuit Breaker Element Weights (Tables 3.1 and 3.2).....	9
 SECTION 4 INITIAL INSPECTION AND INSTALLATION	
4-1 Introduction.....	16
4-2 Manual Operation Check.....	16
4-3 Vacuum Interrupter Integrity	16
4-4 Insulation	16
4-5 Contact Erosion and Wipe.....	16
4-6 Primary Circuit Resistance	16
4-7 Nameplate	16
4-8 Electrical Operation Check.....	17
4-8.1 Circuit Breaker Insertion and Removal.....	17
4-8.2 Operation Check Performance	19
4-9 Circuit Breaker/Structure Interfacing	20
4-9.1 Interface Interlocks/Interfacing Check	20
 SECTION 5 DESCRIPTION AND OPERATION	
5-1 Introduction.....	22
5-2 Interrupter Assembly	22
5-2.1 Vacuum Interrupter.....	22
5-2.2 Contact Erosion Indication	23
5-2.3 "T" Cutout Loading Spring Indicator	23
5-2.4 Contact Wipe and Stroke	23
5-2.5 Phase Barriers.....	23

PAGE

5-3	Stored Energy Mechanism	24
5-3.1	Operation of Stored Energy Mechanism	24
5-3.2	Charging	27
5-3.3	Closing Operation	27
5-3.4	Tripping Operation	27
5-3.5	Trip Free Operation	27
5-4	Control Schemes	27
5-4.1	Timing	29
5-4.2	Secondary Disconnects	29
5-4.3	Undervoltage Trip Device	29
5-5	Interlocks and Interfacing	31
5-6	Levering Mechanism	31
5-7	Operations Counter	31
5-8	Ground Contact	31
5-9	MOC and TOC Switch Operations	31

SECTION 6 INSPECTION, MAINTENANCE AND TROUBLESHOOTING

6-1	Introduction	32
6-2	Frequency of Inspection and Maintenance	32
6-2.1	Qualified Personnel	32
6-2.2	General Torque Guidelines	32
6-3	Inspection and Maintenance Procedures	34
6-4	Vacuum Interrupter Integrity Test	35
6-5	Contact Erosion and Wipe	36
6-6	Insulation	36
6-7	Insulation Integrity Check	37
6-8	Primary Circuit Resistance Check	38
6-9	Mechanism Check	38
6-9.1	CloSure™ Test	38
6-10	Lubrication	42
6-11	Troubleshooting Chart	43

SECTION 7 RENEWAL PARTS

7-1	General	46
7-1.1	Ordering Instructions	46

FIGURES

Figure	Title	Page
1-1	Type VCP-W and Type VCPW-SE Circuit Breaker Outlines and Dimensions in inches	5
1-2	Type VCPW-ND Circuit Breaker Outlines and Dimensions in inches.....	6
3-1	Typical VCP-W Tools and Accessories	11
3-2	Typical Front View VCP-W Vacuum Circuit Breaker Element	12
3-3	Typical VCP-W Vacuum Circuit Breaker Element with Front Cover Removed	13
3-4	Typical Rear View VCP-W Vacuum Circuit Breaker Element.....	14
3-5	Typical VCP-W Vacuum Circuit Breaker Element Escutcheon	15
4-1	Type VCP-W Circuit Breaker Manual Charging Handle in Use	16
4-2	Typical VCP-W Circuit Breaker Compartment.....	18
4-3	Engaging Extension Rails in a Lower Circuit Breaker Compartment.....	19
4-4	Typical VCP-W Circuit Breaker Bottom View	19
4-5	Pulling Secondary Disconnect Cage to Engage Secondaries in TEST Position	20
4-6	Engaging Levering-In Crank.....	20
5-1	Typical VCP-W Rear View Showing Vacuum Interrupters and Current Carrying System.....	22
5-2	Graphic Representation of Arc Interruption	23
5-3	Closing Cam and Trip Linkage	25
5-4	Charging Schematic	26
5-5	Typical VCP-W DC and AC Control Schemes.....	28
5-6	Undervoltage Trip Device Configuration.....	30
6-1	Lubrication Points	33
6-1b	150 VCP-W 63 63kA Pole Unit.....	33
6-2	Vacuum Interrupter Showing Contact Erosion Indicator with Breaker Open	36
6-3	Vacuum Interrupter Showing Contact Erosion Indicator with Breaker Closed.....	36
6-4	Wipe Indication Procedure	37
6-5	Status Indicators	38
6-6	Starting Tape at Bottom of Cam	39
6-7	Wrapping Tape Up Aroung Cam	39
6-8	Attaching Tape Around to Back of Cam	39
6-9	Attaching CloSure™ Test Tool at Hole “A”	39
6-10	Attaching CloSure™ Test Tool at HP.....	40
6-11	Manually Charging Closing Strips.....	40
6-12	Manually Closing Circuit Breaker with Marker in Hole “C”	40
6-13	Top View of CAM and Marker Interface.....	40
6-14	Move Marker 15 ° to Right.....	40
6-15	Move Marker 15 ° to Left	41
6-16	Remove Marker Masking Tape from Cam.....	41
6-17	Place Tape on Right Side Panel of Breaker	41
6-18	Illustrative Testing Tape Sample	41
6-19	Front View of CloSure™ Tool Showing Mounting/Testing Hole Locations	41
6-20	Typical Circuit Breaker Font View with CloSure™ Tool Attached.....	42

TABLES

Table	Title	Page
1.1	Type VCP-W Vacuum Circuit Breaker Through 15 kV Rated Symmetrical Current Basis	2
1.2	Type VCP-W Vacuum Circuit Breaker 27 kV Rated Symmetrical Current Basis	3
1.3	Type VCP-W Extra Capability Vacuum Circuit Breaker 5-15 kV Rated Symmetrical Current Basis	3
1.4	Type VCP-W Generator Vacuum Circuit Breaker 5-15 kV Rated Symmetrical Current Basis	4
1.5	Type VCP-W Generator Vacuum Circuit Breaker Through 17.5 kV Rated Symmetrical Current Basis ...	4
1.6	Type VCP-W Generator Vacuum Circuit Breaker Through 17.5 kV Rated Symmetrical Current Basis....	4
3.1	Type VCP-W ANSI Breaker Weights.....	9
3.2	VCP-W IEC Rated Breaker Weights.....	10
5.1	VCP-W Circuit Breaker Barrier Configurations	24
5.2	Circuit Breaker Timing	29
6.1	Torque Guidelines	33
6.2	Test Voltage.....	35
6.3	Typical Resistance Measurements.....	38
6.4	Closure™ Tool Mounting/Testing Locations by Circuit Breaker Type.....	42
7.1	Recommended Renewal Parts for ANSI Rated Breakers	46
7.2	Recommended Renewal Parts for IEC Rated Breakers.....	53

SECTION 1: INTRODUCTION

1-1 PRELIMINARY COMMENTS AND SAFETY PRECAUTIONS

This technical document is intended to cover most aspects associated with the installation, operation and maintenance of Type VCP-W, VCPW-SE, and VCPW-ND Vacuum Circuit Breakers. It is provided as a guide for authorized and qualified personnel only. Please refer to the specific WARNING and CAUTION in Paragraph 1-1.2 before proceeding past Section 1. If further information is required by the purchaser regarding a particular installation, application or maintenance activity, a Cutler-Hammer representative should be contacted.

1-1.1 WARRANTY AND LIABILITY INFORMATION

NO WARRANTIES, EXPRESSED OR IMPLIED, INCLUDING WARRANTIES OF FITNESS FOR A PARTICULAR PURPOSE OF MERCHANTABILITY, OR WARRANTIES ARISING FROM COURSE OF DEALING OR USAGE OF TRADE, ARE MADE REGARDING THE INFORMATION, RECOMMENDATIONS AND DESCRIPTIONS CONTAINED HEREIN. In no event will Cutler-Hammer be responsible to the purchaser or user in contract, in tort (including negligence), strict liability or otherwise for any special, indirect, incidental or consequential damage or loss whatsoever, including but not limited to damage or loss of use of equipment, plant or power system, cost of capital, loss of power, additional expenses in the use of existing power facilities, or claims against the purchaser or user by its customers resulting from the use of the information and descriptions contained herein.

1-1.2 SAFETY PRECAUTIONS

All safety codes, safety standards and/or regulations must be strictly observed in the installation, operation and maintenance of this device.



WARNING

THE WARNINGS AND CAUTIONS INCLUDED AS PART OF THE PROCEDURAL STEPS IN THIS DOCUMENT ARE FOR PERSONNEL SAFETY AND PROTECTION OF EQUIPMENT FROM DAMAGE. AN EXAMPLE OF A TYPICAL WARNING LABEL HEADING IS SHOWN ABOVE IN REVERSE TYPE TO FAMILIARIZE PERSONNEL WITH THE STYLE OF PRESENTATION. THIS WILL HELP TO INSURE

THAT PERSONNEL ARE ALERT TO WARNINGS, WHICH MAY APPEAR THROUGHOUT THE DOCUMENT. IN ADDITION, CAUTIONS ARE ALL UPPER CASE AND BOLDFACE AS SHOWN BELOW.



CAUTION

COMPLETELY READ AND UNDERSTAND THE MATERIAL PRESENTED IN THIS DOCUMENT BEFORE ATTEMPTING INSTALLATION, OPERATION OR APPLICATION OF THE EQUIPMENT. IN ADDITION, ONLY QUALIFIED PERSONS SHOULD BE PERMITTED TO PERFORM ANY WORK ASSOCIATED WITH THE EQUIPMENT. ANY WIRING INSTRUCTIONS PRESENTED IN THIS DOCUMENT MUST BE FOLLOWED PRECISELY. FAILURE TO DO SO COULD CAUSE PERMANENT EQUIPMENT DAMAGE.

1-2 GENERAL INFORMATION

The purpose of this book is to provide instructions for unpacking, storage, use, operation and maintenance of Type VCP-W, VCPW-SE, and VCPW-ND Vacuum Circuit Breakers. These circuit breakers are horizontal drawout type removable interrupting elements designed for use in VacClad-W Metal-Clad Switchgear and appropriate VCP-W modules. They provide reliable control and protection for medium voltage electrical equipment and circuits. All VCP-W circuit breaker elements are designed to ANSI Standards for reliable performance, ease of handling and simplified maintenance. In addition, VCP-W circuit breakers are tested to both ANSI and IEC Standards for application around the world.

The VCPW-SE circuit breaker element is a VCP-W circuit breaker designed specifically for special environment applications and operating conditions through 27 kV. The VCPW-ND circuit breaker element is a narrow design VCP-W circuit breaker designed specifically for use in 5 kV applications where floor space requirements would not allow the industry standard 36 inch wide switchgear. From this point on, all circuit breaker elements will be referred to as Type VCP-W unless the reference is specific to a particular design.



WARNING

SATISFACTORY PERFORMANCE OF THESE CIRCUIT BREAKER ELEMENTS IS CONTINGENT UPON PROPER APPLICATION, CORRECT INSTALLATION AND ADEQUATE MAINTENANCE. THIS INSTRUCTION

BOOK MUST BE CAREFULLY READ AND FOLLOWED IN ORDER TO OBTAIN OPTIMUM PERFORMANCE FOR LONG USEFUL LIFE OF THE CIRCUIT BREAKER ELEMENTS.

OPERATION WITHIN THEIR NAMEPLATE RATINGS. OPERATION OUTSIDE OF THESE RATINGS MAY CAUSE THE EQUIPMENT TO FAIL, RESULTING IN DEATH, BODILY INJURY AND PROPERTY DAMAGE.



WARNING

ALL SAFETY CODES, SAFETY STANDARDS AND/OR REGULATIONS AS THEY MAY BE APPLIED TO THIS TYPE OF EQUIPMENT MUST BE STRICTLY ADHERED TO.

THE CIRCUIT BREAKER ELEMENTS DESCRIBED IN THIS BOOK ARE DESIGNED AND TESTED TO OPER-

1-3 TYPE VCP-W VACUUM CIRCUIT BREAKER ELEMENT RATINGS (TABLES 1.1, 1.2, 1.3, 1.4, 1.5 AND 1.6)

Table 1.1 (ANSI Standards^①) Type VCP-W Vacuum Circuit Breaker Through 15 kV Rated Symmetrical Current Basis

Identification Circuit Breaker Type	Nominal		Rated Values				Current		Inter-rupting Time ^④	Permis-sible Tripping Delay	Maximum Voltage Divided By K	Current Values			
	Voltage Class	3-Phase MVA Class	Maximum Voltage	Voltage Range Factor ^③	Insulation Level Withstand Test Voltage		Continuous Current at 60 Hz	Short Circuit Current (at Rated Max. kV)				K Times Rated Short Circuit Current ^{③ ⑤}	Closing and Latching Capability	Closing and Latching Capability Momentary	
					Power Frequency (1 Min.)	Impulse									Maximum Symmetrical Interrupting Capability
kV	MVA	kV rms	K	kV rms	kV Peak	Amperes	kA rms	Cycles	Seconds	kV rms	kA rms	kA Peak	kA rms		
50VCPW-ND250	4.16	250	4.76	1.24	19	60	1200	29	5	2	3.85	36	97	58	
50VCP-W250	4.16	250	4.76	1.24	19	60	1200 2000 3000	29	5	2	3.85	36	97 132 ^②	58 78 ^②	
50VCP-W350	4.16	350	4.76	1.19	19	60	1200 2000 3000	41	5	2	4.0	49	132	78	
75VCP-W500	7.2	500	8.25	1.25	36	95	1200 2000 3000	33	5	2	6.6	41	111	66	
150VCP-W500	13.8	500	15	1.30	36	95	1200 2000 3000	18	5	2	11.5	23	62 97 ^②	37 58 ^②	
150VCP-W750	13.8	750	15	1.30	36	95	1200 2000 3000	28	5	2	11.5	36	97 130 ^②	58 77 ^②	
150VCP-W1000	13.8	1000	15	1.30	36	95	1200 2000 3000	37	5	2	11.5	48	130	77	
150VCP-W1500(63)	13.8	1500	15	1.00	36	95	1200 2000 3000	63	5	2	15.0	63	170	101	

① Applicable ANSI Standards C37.04-1979, C37.09-1979 and C37.06-1987. Operating Duty Cycle CO-15 seconds-CO. Operating Time Values: Opening 30-45 ms, Closing 45-60 ms and Reclosing 18 cycles (300 rms).

② Non-standard circuit breakers with High Close and Latch (momentary) rating for special applications.

③ Consult Application Data 32-265 for further information.

④ Optional interrupting time of 3 cycles is available.

⑤ Also 3-second short time current carrying capability.

Table 1.2 (ANSI Standards^①) Type VCP-W Vacuum Circuit Breaker 27 kV Rated Symmetrical Current Basis

Circuit Breaker Type	Nominal		Rated Values				Current Continuous Current at 60 Hz	Short Circuit Current ^⑤	Interrupting Time ^④	Permissible Tripping Delay	Transient Recovery Voltage		Current Values	
	Voltage Class	3-Phase MVA Class	Voltage		Insulation Level						E ₂	I ₂ Rise Time	Closing and Latching Capability	Capacitor Switching Cable Charging
			Maximum Voltage ^②	Voltage Range Factor ^③	Withstand Test Voltage									
					Power Frequency (1 Min.)	Impulse								
kV	MVA	kV rms	K	kV rms	kV Peak	Amperes	kA rms	Cycles	Seconds	kV Peak	µs	kA Peak	Amperes	
270VCP-W750(16)	27	750	27	1.0	60	125	600 1200 2000	16	5	2	51	105	43	31.5
270VCP-W1000(22)	27	1000	27	1.0	60	125	600 1200 2000	22	5	2	51	105	60	31.5
270VCP-W1250(25)	27	1250	27	1.0	60	125	600 1200 2000	25	5	2	51	105	68	31.5
270VCP-W1600(32)	27	1600	27	1.0	60	125	1200 2000	31.5	5	2	51	105	85	31.5
270VCP-W2000(40)	27	2000	27	1.0	60	125	1200 2000	40	5	2	51	105	106	31.5

① CESI tested to applicable ANSI Standards C37.04 - 1979, C37.09 - 1979, and C37.06 - 199X. Consult Cutler-Hammer for CESI reports on file. Operating duty cycle CO-15 seconds-CO. Operating time values: opening 33-55 ms, closing 50-60 ms and reclosing 18 cycles (300 ms).

② Testing at 28.5 kV.

③ K=1.0, therefore E = E/K and I = KI. Consult Application Data 32-265 for further information.

④ Optional interrupting time of 3 cycles is available.

⑤ Also maximum interrupting rating.

Table 1.3 (ANSI Standards) Type VCP-WC Extra Capability Vacuum Circuit Breaker 5-15 kV Rated Symmetrical Current Basis

Circuit Breaker Type	Voltage		Insulation Level		Current						Interrupting Time (1)	Maximum Permissible Tripping Delay	Transient Recovery Voltage (RRRV)	Capacitor Switching Ratings				Mechanical Endurance		
	Max Voltage V	Voltage Range Factor K	Withstand Test		Continuous Current at 60 Hz	Short-Circuit Current								General Purpose	Definite Purpose					
			Power Frequency (1 Min.)	Lightening Impulse 1.2x50µs		kA rms Total	% dc component (I _{dc})	Asym. Interrupting (I ₁)	Closing & Latching Capability	Short-Time Current for 3 sec.					Isolated Shunt Capacitor Bank Current	Back to Back Capacitor Switching				
																A rms	A rms		kA Peak	kHz
kV rms		kV rms	kV Peak	A rms	kA rms Total	%	kA rms	kA Peak	kA rms	ms	Seconds	kV / µs	A rms	A rms	kA Peak	kHz	No-Load Operations			
50 VCP-W 40C	5.95	1	24	75	1200 2000 3000	40	75	58	139	40	50	2	0.9 0.9 0.8	630 (5) 1000 (5)	15 18	3.5 2.7	10,000 10,000 5,000			
50 VCP-W 50C	5.95	1	24	75	1200 2000 3000	50	57 57 52	64 64 62	139	50	50	2	0.9 0.9 0.8	630 (5) 1000 (5)	15 18	3.5 2.7	10,000 10,000 5,000			
75 VCP-W 50C	10.3	1	42	95	1200 2000 3000	50	57 57 52	64 64 62	139	50	50	2	0.9 0.9 0.8	630 (5) 1000 (5)	15 18	3.5 2.7	10,000 10,000 5,000			
150 VCP-W 25C	17.5	1	42	95	1200 2000 3000	25	50 75 75	31 36 36	97 (2)	25	50	2	0.95 0.9 0.8	600 (6) 1000 (5)(6)	20 18	3.5 2.7	10,000 10,000 5,000			
150 VCP-W 40C	17.5	1	42	95	1200 2000 3000	40	75	58	139	40	50	2	0.9 0.9 0.8	630 (5)(6) 1000 (5)(6)	15 18	3.5 2.7	10,000 10,000 5,000			
150 VCP-W 50C	17.5	1	42	95	1200 2000 3000	50	57 57 52	64 64 62	139	50	50	2	0.9 0.9 0.8	630 (5)(6) 1000 (5)(6)	15 18	3.5 2.7	10,000 10,000 5,000			
270 VCP-W 25C	27	1	60	125	1200 1600	25	75	36	85	25 (8)	50	2	1.1	400	20	4.2	2,500			
270 VCP-W 32C	27	1	60	125	1200 1600	31.5	57	40	97	32 (7)	50	1	1.1	400	20	4.2	2,500			
270 VCP-W 40C	27	1	60	125	1200 1600	40	50	49	104	40 (7)	50	1	1.1	400	20	4.2	2,500			

(1) 3 cycles

(2) Close & Latch Current for 1200A Type 150 VCP-W 25C is proven at 15kV. For sealed interrupters at high altitudes, switching voltage is not de-rated.

(3) For higher RRRV contact Cutler-Hammer for more information.

(4) Breaker tested to 2700A single bank switching for momentary load (Thermal derating must consider harmonic content of current waveform).

(5) Breaker tested to 1270A back to back switching for momentary load (Thermal derating must consider harmonic content of

current waveform).

(6) Capacitor Switching Ratings are proven at 15kV. For sealed interrupters at high altitudes, switching voltage is not de-rated.

(7) 1 second

(8) 2 seconds

Table 1.4 (ANSI Standards) Type VCP-WG Generator Vacuum Circuit Breaker Through 5-15 kV Rated Symmetrical Current Basis

Circuit Breaker Type	Rated Values											
	Voltage		Insulation Level		Current		Interrupting Time	Permissible Tripping Time	Maximum Voltage Divided by K	Peak Voltage E2	Time-to-Peak t2	Close and Latch Capability Momentary
	Maximum Voltage	Voltage Range Factor	Withstand Test Voltage		Continuous Current at 60 Hz	Short Circuit Current (at Rated Maximum kV)						
	E	K	Power Frequency (1 minute)	Impulse	Amperes	I						
kV rms		kV rms	kV Peak		kA rms	Cycles	Seconds	kV rms	kV	µs	kA Peak	
50VCP-WG50	4.76	1	19	60	1200 2000 3000	50	3	2	4.76	27	8.8	137
50VCP-WG63	4.76	1	19	60	1200 2000 3000	63	3	2	4.76	28	9.0	173
150VCP-WG50	15.0	1	36	95	1200 2000 3000	50	3	2	15.0	27	3.5	137
150VCP-WG63	15.0	1	36	95	1200 2000 3000	63	3	2	15.0	28	3.5	173

Table 1.5 (IEC-56 Standards^①) Type VCP-W Vacuum Circuit Breaker Through 17.5 kV Rated Symmetrical Current Basis

Circuit Breaker Type	Voltage Class	Rated Values							
		Insulation Level		Normal Current	Short Circuit Breaking Current	3 Second Short Time Current	Short Circuit Making Current	Cable Charging Breaking Amps	
		Power Frequency	Impulse Withstand						
kV rms	kV Peak	kV Peak	Amperes	kA rms	kA rms	kA Peak	Amperes		
36VCPW-ND25	3.6	10	40	630, 1250	25	25	63	25	
36VCPW-ND32	3.6	10	40	630, 1250	31.5	31.5	79	25	
72VCPW-ND25	7.2	20	60	630, 1250	25	25	63	25	
72VCPW-ND32	7.2	20	60	630, 1250	31.5	31.5	79	25	
36VCP-W25	3.6	10	40	630, 1250, 2000	25	25	63	25	
36VCP-W32	3.6	10	40	1250, 2000	31.5	31.5	79	25	
36VCP-W40	3.6	10	40	1250, 2000	40	40	100	25	
72VCP-W25	7.2	20	60	630, 1250, 2000	25	25	63	25	
72VCP-W32	7.2	20	60	1250, 2000	31.5	31.5	79	25	
72VCP-W40	7.2	20	60	1250, 2000	40	40	100	25	
120VCP-W25	12.0	28	75	630, 1250, 2000	25	25	63	25	
120VCP-W32	12.0	28	75	1250, 2000	31.5	31.5	79	25	
120VCP-W40	12.0	28	75	1250, 2000	40	40	100	25	
175VCP-W25	17.5	38	95	1250, 2000	25	25	63	31.5	
175VCP-W32	17.5	38	95	1250, 2000	31.5	31.5	79	31.5	
175VCP-W40	17.5	38	95	1250, 2000	40	40	100	31.5	

① Interrupting time is 3 cycles at 50/60 Hz. Rated operating sequence O-3 min-CO-3 min-CO.

Table 1.6 (IEC-56 Standards^①) Type VCP-W Vacuum Circuit Breaker Through 24 kV Rated Symmetrical Current Basis

Circuit Breaker Type	Voltage ②	Insulation Level			Normal Current	Short Circuit Breaking Current	Transient Recovery Voltage			Short Time (3 Second) Current	Short Circuit Making Current	Cable Charging Breaking Current
		Power Frequency	Lightning Impulse Withstand				U _c	i ₃	i _d			
		kV rms	kV rms	kV Peak	Amperes	kA rms	kA Peak	µs	µs	kA rms	kA Peak	Amperes
240VCP-W16	24	60	125	630 1250 2000	16	41	88	13	16	40	31.5	
240VCP-W20	24	60	125	630 1250 2000	20	41	88	13	20	50	31.5	
240VCP-W25	24	60	125	630 1250 2000	25	41	88	13	25	63	31.5	

① CESI certified for rated operating sequence: O-0.3 seconds-CO-15 seconds-CO in accordance with IEC 56. Consult Cutler-Hammer for CESI certificates on file.

② Tested at 28.5 kV.

1-4 OUTLINES AND DIMENSIONS

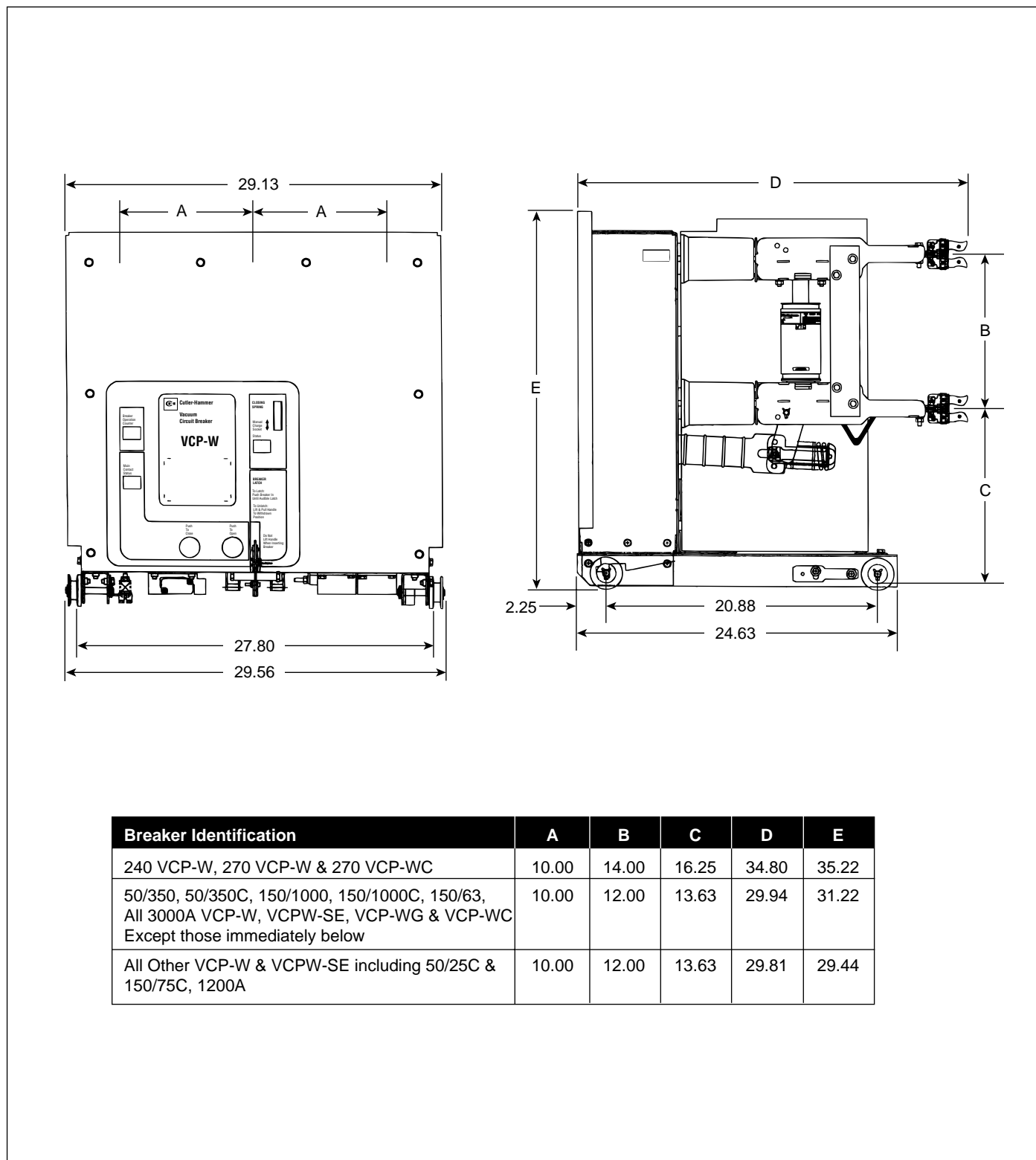

Figure 1-1 Type VCP-W and Type VCPW-SE Circuit Breaker Outlines and Dimensions in inches

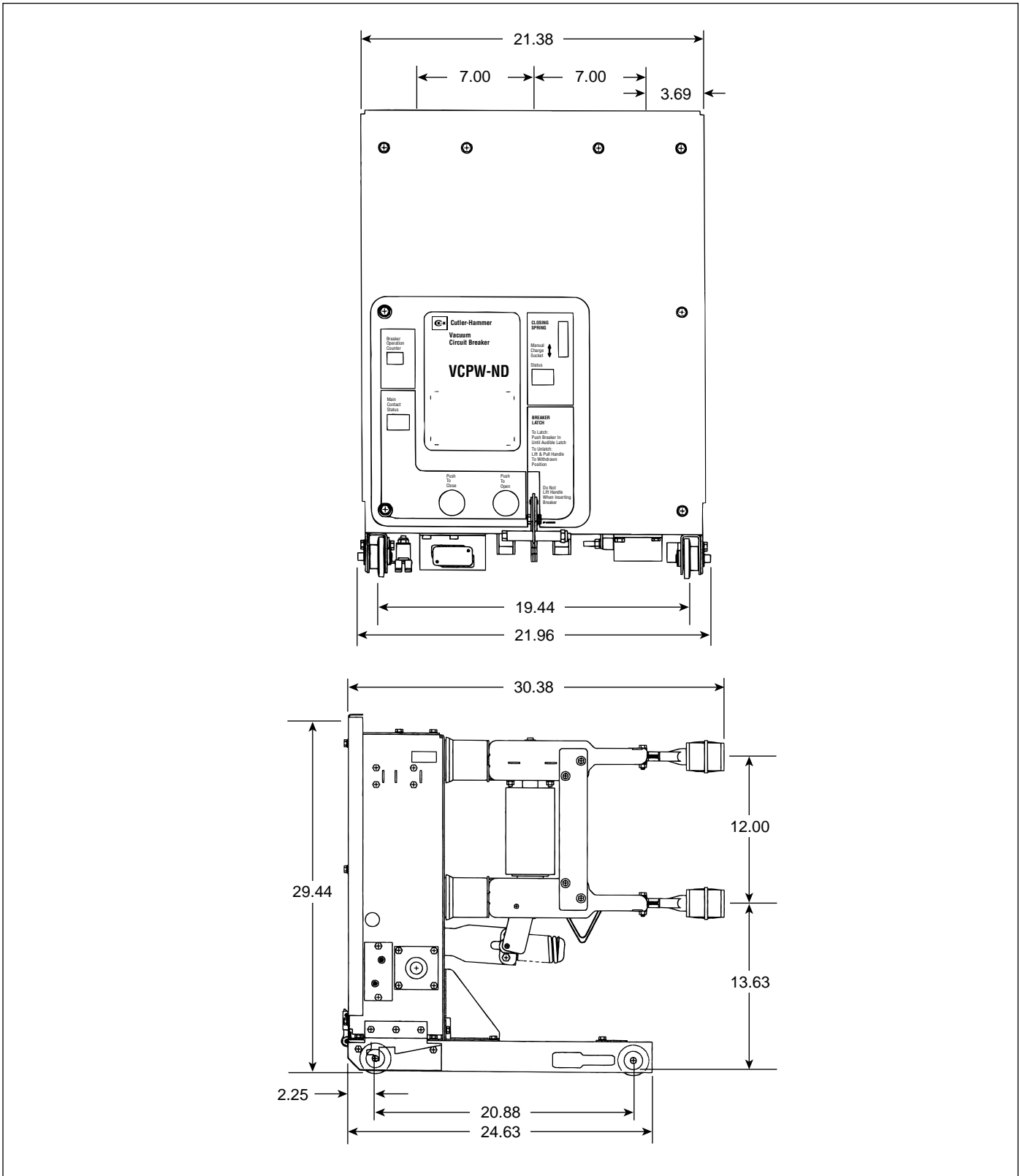

Figure 1-2 Type VCPW-ND Circuit Breaker Outlines and Dimensions in inches

SECTION 2: SAFE PRACTICES

2-1 RECOMMENDATIONS

Type VCP-W Vacuum Circuit Breaker Elements are equipped with high speed, high energy operating mechanisms. They are designed with several built-in interlocks and safety features to provide safe and proper operating sequences.



WARNING

TO PROTECT THE PERSONNEL ASSOCIATED WITH INSTALLATION, OPERATION, AND MAINTENANCE OF THESE CIRCUIT BREAKER ELEMENTS, THE FOLLOWING PRACTICES MUST BE FOLLOWED:

- Only qualified persons, as defined in the local electrical code, who are familiar with the installation and maintenance of medium voltage circuits and equipment, should be permitted to work on these circuit breaker elements.
- Read these instructions carefully before attempting any installation, operation or maintenance of these breakers.
- Always remove the breakers from the enclosure before performing any maintenance. Failure to do so could result in electrical shock leading to death, severe personal injury or property damage.
- BE EXTREMELY CAREFUL while the circuit breaker is on the extension rails. Use provided rail clamps to firmly hold the circuit breaker on the extension rails while performing such activities as charging, closing and tripping. Carelessness could cause the circuit breaker to fall from the rails resulting in personal injury to those in the area.
- Do not work on a closed breaker or a breaker with closing springs charged. The closing spring should be discharged and the main contacts open before working on the breaker. Failure to do so could result in cutting or crushing injuries.
- Do not use a circuit breaker by itself as the sole means of isolating a high voltage circuit. Remove the breaker to the DISCONNECT position and follow good lockout and tagging rules, as well as all applicable codes, regulations and work rules.
- Do not leave the breaker in an intermediate position in the cell. Always have the breaker either in the TEST or CONNECTED position. Failure to do so could result in a flash over and possible death, personal injury or property damage.
- Always remove the maintenance tool from the breaker after charging the closing springs.
- Breakers are equipped with safety interlocks. Do not defeat them. This may result in death, bodily injury or equipment damage.

SECTION 3: RECEIVING, HANDLING AND STORAGE

3-1 GENERAL

Type VCP-W Vacuum Circuit Breaker Elements are subjected to complete factory production tests and inspection before being packed. They are shipped in packages designed to provide maximum protection to the equipment during shipment and storage and at the same time to provide convenient handling. Tools, such as the maintenance tool, are shipped separately.

3-2 RECEIVING

If the circuit breaker element is not to be used immediately but is to be placed in storage; maximum protection can be obtained by keeping it packed as shipped.

Upon receipt of the equipment, inspect the containers for any signs of damage or rough handling. Open the containers carefully to avoid any damage to the contents. Use a nail puller rather than a crow bar when required. When opening the containers, be careful to save any loose items or hardware that may be otherwise discarded with the packing material. Check the contents of each package against the packing list.

Examine the circuit breaker element for any signs of shipping damage such as broken, missing or loose hardware, damaged or deformed insulation and other components. File claims immediately with the carrier if damage or loss is detected and notify the nearest Cutler-Hammer Office.

3-3 HANDLING



CAUTION

DO NOT USE ANY LIFTING DEVICE AS A PLATFORM FOR PERFORMING MAINTENANCE, REPAIR OR ADJUSTMENT OF THE BREAKER OR FOR OPENING, CLOSING THE CONTACTS OR CHARGING THE SPRINGS. THE CIRCUIT BREAKER ELEMENT MAY SLIP OR FALL CAUSING SEVERE PERSONAL INJURY. ALWAYS PERFORM MAINTENANCE, REPAIR AND ADJUSTMENTS ON A SOLID WORK SURFACE CAPABLE OF SUPPORTING THE BREAKER ELEMENT.

When a breaker element is ready for installation, a lifting yoke in conjunction with an overhead lifter or portable floor lifter can be used to move a breaker element.

When a breaker element is to be lifted, position the lifting yoke over the breaker element and insert lifters into the breaker element side openings with the lifting hole toward the interrupters. Once the lifting yoke is securely seated in the holes, the breaker element can be carefully lifted and moved.

3-4 STORAGE

If the circuit breaker element is to be placed in storage, maximum protection can be obtained by keeping it packed as shipped. Before placing it in storage, checks should be made to make sure that the breaker element is free from shipping damage and is in satisfactory operating condition.

The circuit breaker element is shipped with its contacts open and closing springs discharged. The indicators on the front panel should confirm this. Insert the maintenance tool in the manual charge socket opening (Figure 3-3). Charge the closing springs by pumping the handle up and down approximately 38 times until a crisp metallic “click” is heard. This indicates that the closing springs are charged and is shown by the closing spring “charged” (yellow) indicator. Remove the maintenance tool. Operate the push-to-close button. The breaker element will close as shown by the breaker contacts “closed” (red) indicator. Operate the push-to-open button. The breaker element will trip as shown by the breaker contacts “open” (green) indicator. After completing this initial check, leave the closing springs “discharged” and breaker contacts “open”.

Outdoor storage of the breaker element is NOT recommended. If unavoidable, the outdoor location must be well drained and a temporary shelter from sun, rain, snow, corrosive fumes, dirt, falling objects and excessive moisture must be provided. Containers should be arranged to permit free circulation of air on all sides and temporary heaters should be used to minimize condensation. Moisture can cause rusting of metal parts and deterioration of high voltage insulation. A heat level of approximately 400 watts for each 100 cubic feet of volume is recommended with the heaters distributed uniformly throughout the structure near the floor.

Indoor storage should be in a building with sufficient heat and air circulation to prevent condensation. If the building is not heated, the same general rule for heat as for outdoor storage should be applied.

3-5 TOOLS AND ACCESSORIES

Tools and accessories, both standard and optional are available for use with the circuit breaker element (Figure 3-1).

Spin-Free Levering-In Crank: Used to crank breaker between TEST and CONNECTED positions (Style 701B601G11).

Standard Levering-In Crank: (Style 701B601G12).

Maintenance Tool: Used to charge closing springs manually (Style 8064A02G11).

Extension Rails: Permits breaker to be withdrawn from its compartment (Style 7813C41G03 for VCP-W and VCPW-SE) and (Style 7813C41G04 for VCPW-ND).

Rail Clamps: Used to secure breaker to extension rails (Style 6511C83G11 for VCP-W and VCP-SE) and (Style 6511C83G02 for VCPW-ND).

Lifting Yoke: Used to lift breaker (Style 691C607G11 for VCP-W and VCPW-SE) and (Style 691C607G02 for VCPW-ND).

Drawout Ramp: Used to insert or withdraw breaker from lower compartment without portable lifter (Style 1C14163G02 for VCP-W and VCPW-SE) and (Style 1C14163G01 for VCPW-ND).

Portable Lifter: Used to lift breaker to or from extended rails (Style 1C14504H01).

Docking Transport Dolly: Used to insert or withdraw breaker from lower compartment without portable lifter or move breaker from one location to another (Style 6510C71G11 for VCP-W and VCPW-SE) and (Style 6510C71G02 for VCPW-ND).

Electrical Levering-In Device: Used to electrically move breaker between TEST and CONNECTED positions (Style 1A30257G01).

Test Jumper: Used to operate breaker electrically while breaker is on extension rails or transport dolly (Style 6526C23G11 for VCP-W and VCPW-SE) and (Style 1C15331G01 for VCPW-ND).

Test Cabinet: Used to provide power to operate breaker outside its compartment (Styles 8346A28G21 – G23 for VCP-W and VCPW-SE depending upon voltage requirements) and (Styles 8346A28G41 – 43 for VCPW-ND depending upon voltage requirements).

3-6 TYPE VCP-W VACUUM CIRCUIT BREAKER ELEMENT WEIGHTS (TABLES 3.1 AND 3.2)

Table 3.1 VCP-W ANSI Rated Breaker Weights^①

Rating	Amperes	Lbs. (kg)
50VCPW-ND250	1200	345 (157)
50VCP-W250	1200	350 (159)
50VCPW-SE250	2000 3000	410 (186) 525 (238)
50VCP-W350	1200	460 (209)
50VCPW-SE350	2000 3000	490 (222) 525 (238)
75VCP-W500	1200	375 (170)
75VCPW-SE500	2000 3000	410 (186) 525 (238)
150VCP-W500	1200	350 (159)
150VCPW-SE500	2000 3000	410 (186) 525 (238)
150VCP-W750	1200	350 (159)
150VCPW-SE750	2000 3000	410 (186) 525 (238)
150VCP-W1000	1200	460 (209)
150VCPW-SE1000	2000 3000	490 (222) 525 (238)
150VCP-W1500(63)	1200	525 (238)
150VCPW-SE1500(63)	2000 3000	530 (241) 550 (250)
270VCP-W750(16)	600 1200 2000	460 (209) 480 (218) 500 (227)
270VCP-W1000(22)	600 1200 2000	460 (209) 480 (218) 500 (227)
270VCP-W1250(25)	600 1200 2000	460 (209) 480 (218) 500 (227)
270VCP-W1600(32)	1200 2000	545 (245) 560 (252)
270VCP-W2000(40)	1200 2000	545 (245) 560 (252)

^① Does not include shipping carton.

Table 3.2 VCP-W IEC Rated Breaker Weights^①

Rating	Normal Current Amperes	Lbs. (kg)
36VCPW-ND25	630	350 (159)
	1250	350 (159)
36VCPW-ND32	630	350 (159)
	1250	350 (159)
72VCPW-ND25	630	350 (159)
	1250	350 (159)
72VCPW-ND32	630	350 (159)
	1250	350 (159)
36VCP-W25	630	350 (159)
	1250	350 (159)
	2000	410 (186)
36VCP-W32	1250	350 (159)
	2000	410 (186)
36VCP-W40	1250	375 (170)
	2000	410 (186)
72VCP-W25	630	350 (159)
	1250	350 (159)
	2000	410 (186)
72VCP-W32	1250	350 (159)
	2000	410 (186)
72VCP-W40	1250	375 (170)
	2000	410 (186)
120VCP-W25	630	350 (159)
	1250	350 (159)
	2000	410 (186)
120VCP-W32	1250	350 (159)
	2000	410 (186)
120VCP-W40	1250	375 (170)
	2000	410 (186)
175VCP-W25	630	350 (159)
	1250	350 (159)
	2000	410 (186)
175VCP-W32	1250	375 (170)
	2000	410 (186)
175VCP-W40	1250	375 (170)
	2000	410 (186)
240VCP-W16	630	462 (210)
	1250	484 (220)
	2000	506 (230)
240VCP-W20	630	462 (210)
	1250	484 (220)
	2000	506 (230)
240VCP-W25	630	462 (210)
	1250	484 (220)
	2000	506 (230)

① Does not include shipping carton.



Optional portable lifter

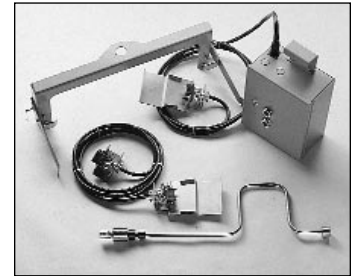

Optional accessories

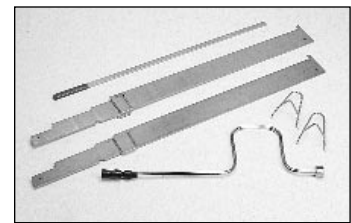

Standard accessories

Optional dockable dolly

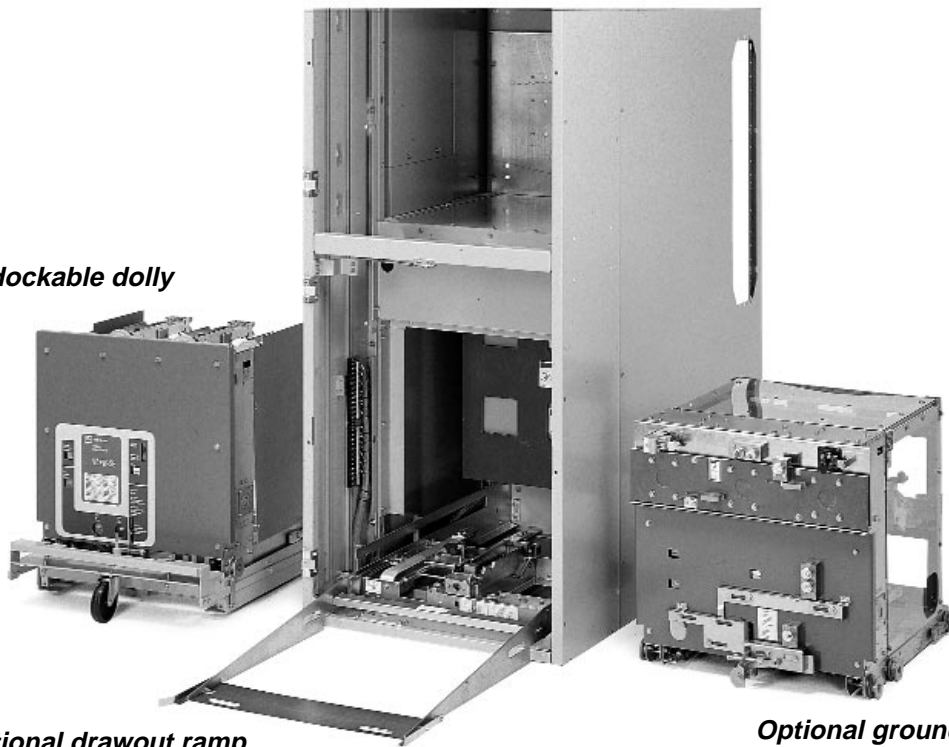

Optional drawout ramp

Optional ground and test devices and dummy elements

Figure 3-1 Typical VCP-W Tools and Accessories

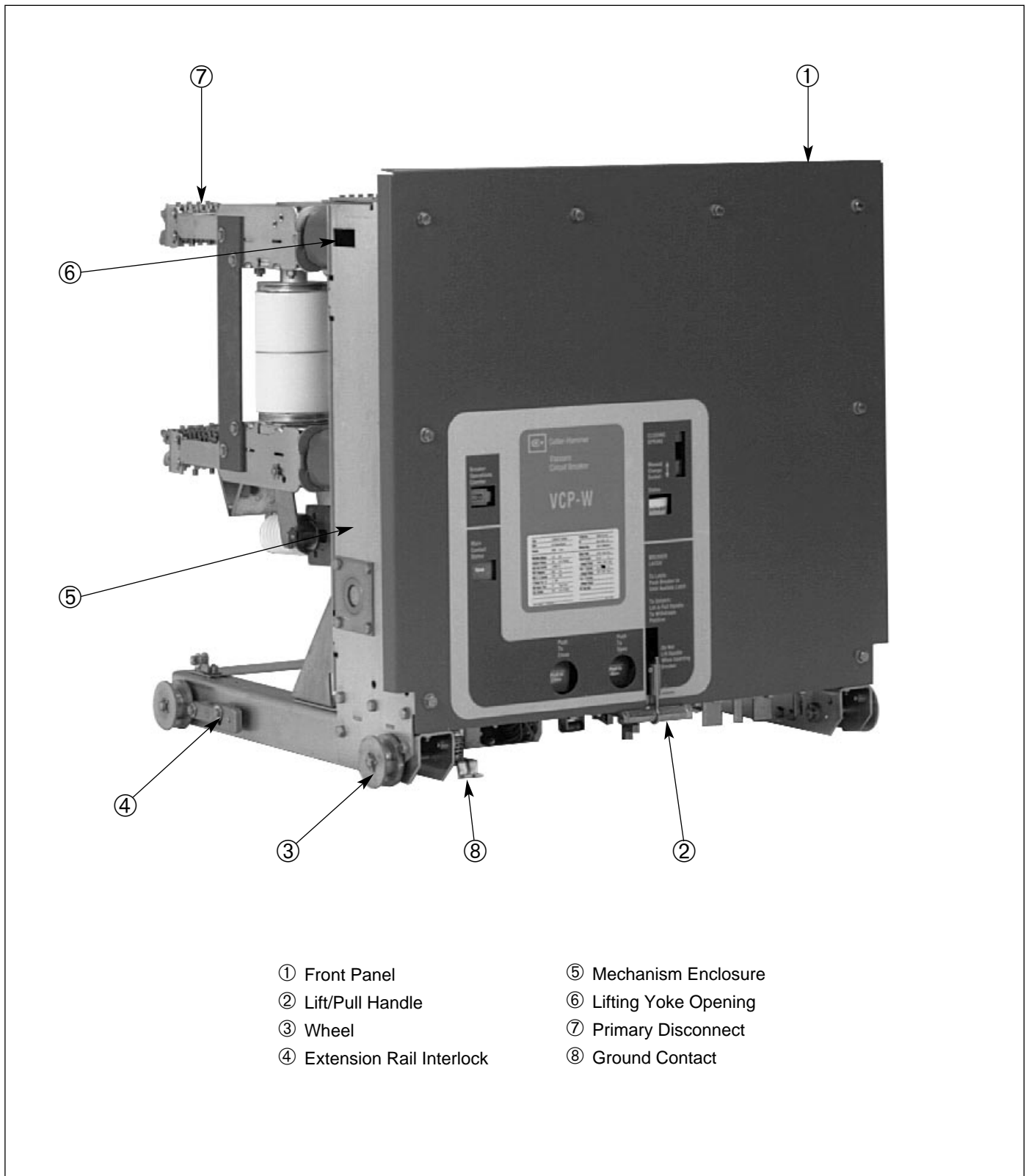

- | | |
|----------------------------|------------------------|
| ① Front Panel | ⑤ Mechanism Enclosure |
| ② Lift/Pull Handle | ⑥ Lifting Yoke Opening |
| ③ Wheel | ⑦ Primary Disconnect |
| ④ Extension Rail Interlock | ⑧ Ground Contact |

Figure 3-2 Typical Front View VCP-W Vacuum Circuit Breaker Element

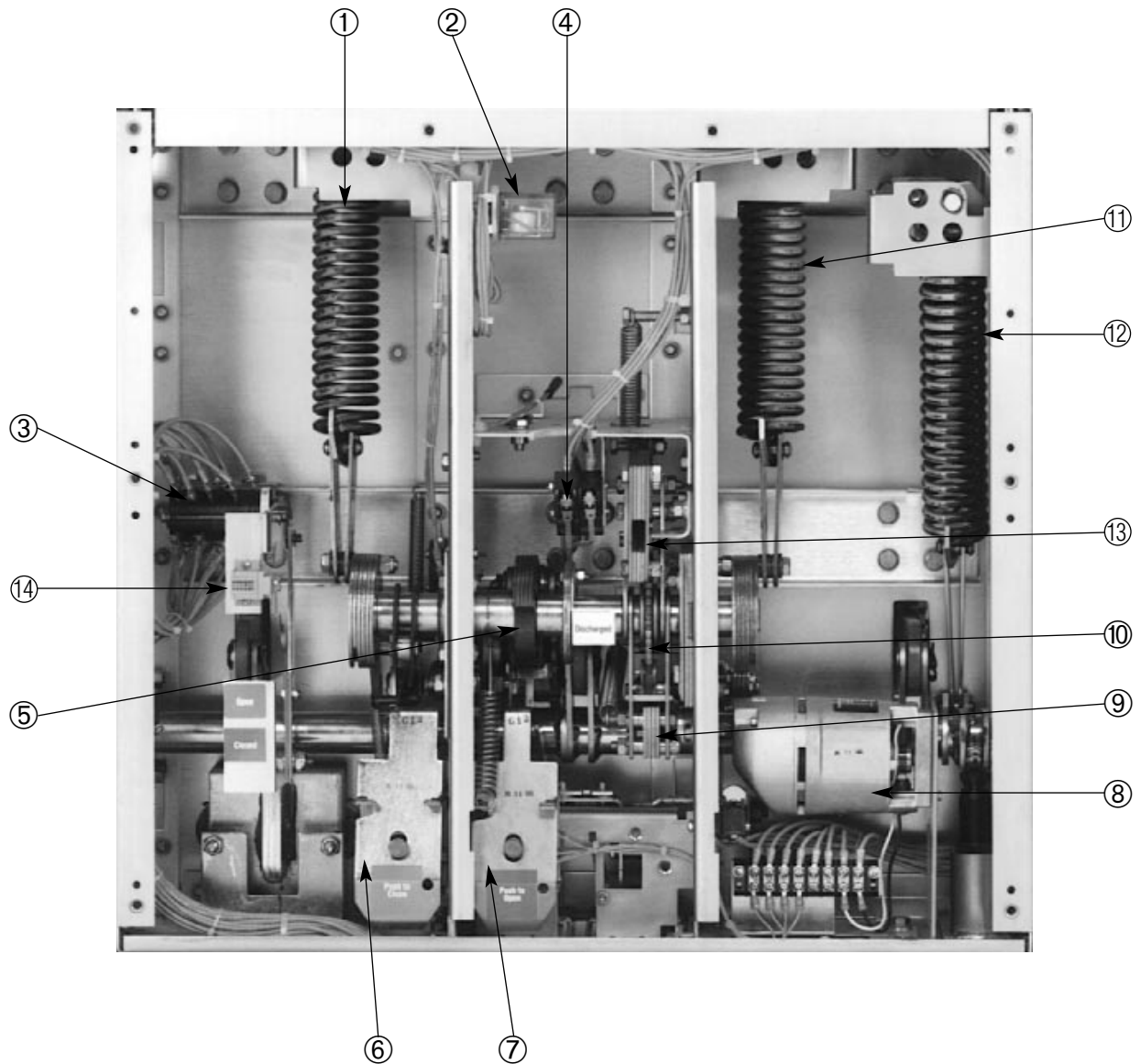

- | | | |
|-----------------------|--|------------------------|
| ① L.H. Closing Spring | ⑥ Spring Release (Close Coil) Assembly | ⑪ R. H. Closing Spring |
| ② Anti-Pump Relay | ⑦ Shunt Trip Assembly | ⑫ Opening Spring |
| ③ Auxiliary Switch | ⑧ Charging Motor | ⑬ Manual Charge Socket |
| ④ Motor Cutoff Switch | ⑨ Charging Pawl | ⑭ Operation Counter |
| ⑤ Closing Cam | ⑩ Ratchet Wheel | |

Figure 3-3 Typical VCP-W Vacuum Circuit Breaker Element with Front Cover Removed

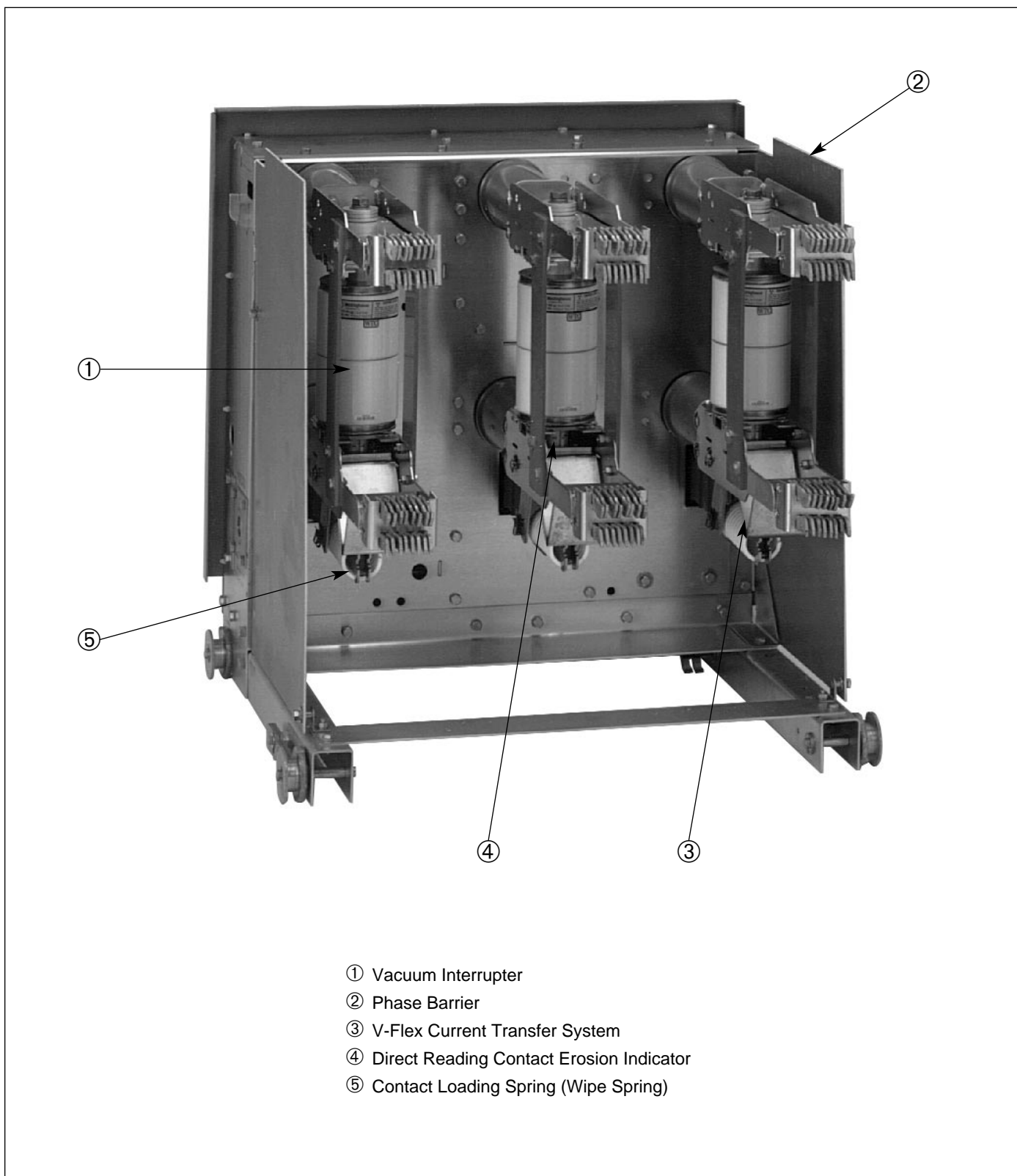
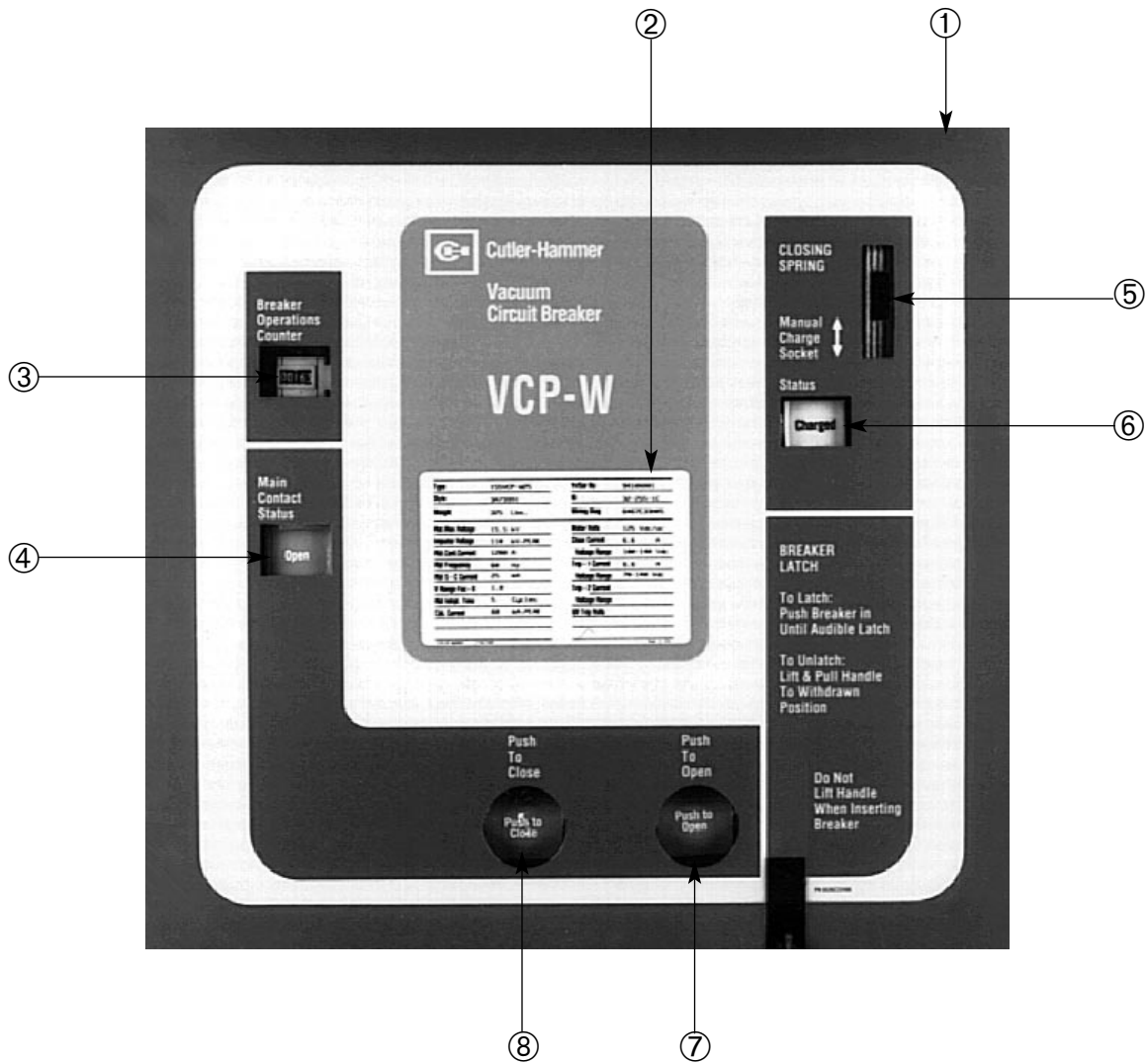

Figure 3-4 Typical Rear View VCP-W Vacuum Circuit Breaker Element



- ① Front Panel
- ② Nameplate
- ③ Operation Counter
- ④ Open/Closed Indicator
- ⑤ Manual Charge Socket
- ⑥ Spring Charged/Discharged Indicator
- ⑦ Manual Open Button
- ⑧ Manual Close Button

Figure 3-5 Typical VCP-W Vacuum Circuit Breaker Element Escutcheon

SECTION 4: INITIAL INSPECTION AND INSTALLATION

4-1 INTRODUCTION



WARNING

BEFORE PLACING THE CIRCUIT BREAKER IN SERVICE, CAREFULLY FOLLOW THE INSTALLATION PROCEDURE GIVEN BELOW. NOT FOLLOWING THE PROCEDURE CAN FAIL TO UNCOVER SHIPPING DAMAGE THAT MAY RESULT IN INCORRECT CIRCUIT BREAKER OPERATION LEADING TO DEATH, BODILY INJURY, AND EQUIPMENT DAMAGE.

Before attempting to put a circuit breaker in service, it should be carefully examined and operated manually and electrically. In addition, carefully examine the breaker for loose or obviously damaged parts. The following information is a guide for performing recommended checks and tests.

4-2 MANUAL OPERATION CHECK

Refer to Figures 3-5 and 4-1 and then proceed by placing the maintenance tool into the manual charge socket opening. Charge the closing springs with about 38 up and down strokes of the handle. When charging is complete the closing crank goes over center with an audible **CLICK** and the springs Charged/Discharged indicator shows "Charged."

NOTICE

If the springs are to be charged on a closed circuit breaker, no click is heard at the end of charging operation. Discontinue charging and remove the maintenance tool as soon as "Charged" flag is fully visible. Continued attempts to charge further may result in damage to the mechanism.

Remove the maintenance tool. Close and trip the circuit breaker. Repeat several times.

4-3 VACUUM INTERRUPTER INTEGRITY

Using a dry, lint free cloth or paper towel, clean all the accessible insulating surfaces of the pole units. Conduct a vacuum interrupter integrity check as described in Section 6.

4-4 INSULATION

Check the circuit breaker's primary and secondary insulation as described in Section 6.

4-5 CONTACT EROSION AND WIPE

Manually charge the closing springs and close the circuit breaker. Check contact erosion and wipe as described in Section 6.

4-6 PRIMARY CIRCUIT RESISTANCE

Check the primary circuit resistance as described in Section 6. The resistance should not exceed the values specified. Record the values obtained for future reference.

4-7 NAMEPLATE

Compare the circuit breaker nameplate information with switchgear drawings for compatibility.



Figure 4-1 Type VCP-W Circuit Breaker Manual Charging Handle in Use

4-8 ELECTRICAL OPERATION CHECK

After having completed all previous checks and tests, the circuit breaker is ready to be operated electrically. It is preferred that this check be made with the circuit breaker in a TEST position or by using a test cable, if the circuit breaker is outside the cell structure.



CAUTION

BEFORE INSERTING THE CIRCUIT BREAKER EXAMINE THE INSIDE OF THE CELL STRUCTURE FOR EXCESSIVE DIRT OR ANYTHING THAT MIGHT INTERFERE WITH THE CIRCUIT BREAKER MOVEMENT.



WARNING

EXTREME CAUTION MUST BE EXERCISED TO INSURE THAT PRIMARY CIRCUITS ARE NOT ENERGIZED WHILE CHECKS ARE PERFORMED IN THE CIRCUIT BREAKER COMPARTMENT. FAILURE TO DO SO MAY RESULT IN PERSONAL INJURY OR DEATH.

The circuit breaker is normally tested electrically in its cell structure in the TEST position. To achieve the TEST position, the circuit breaker must first be placed in the cell structure and the secondary contacts engaged. To complete this testing procedure, the operator should first be familiar with inserting and removing the circuit breaker into and from the cell structure.

4-8.1 CIRCUIT BREAKER INSERTION AND REMOVAL

NOTICE

Make certain that the levering nut is all the way forward in the TEST position before attempting to insert a circuit breaker into its compartment (Figure 4-2).

If the circuit breaker is being inserted into an upper compartment or will be positioned in a lower compartment **without the use of a drawout ramp or dockable dolly**, the extension rails must first be put in position. Carefully engage the left and right extension rails to the fixed structure rails and ensure they are properly seated in place (Figure 4-3). Once the extension rails are prop-

erly in place, the circuit breaker can be carefully loaded on the extension rails using an overhead lifter and lifting yoke. Remove the lifting yoke when the circuit breaker is securely seated on the extension rails.

Push the circuit breaker into the compartment until the TEST position is reached as confirmed by a metallic sound of the breaker levering latch engaging the levering nut (Figures 4-2 and 4-4). Once the circuit breaker is in the TEST position, the extension rails can be removed.

To engage the circuit breaker secondary contacts, raise the handle to the secondary disconnect cage and pull the cage forward as far as possible (Figure 4-5). As soon as control power is available, the motor will start charging the closing springs.



CAUTION

DO NOT USE ANY TOOL OTHER THAN THE LEVERING-IN CRANK PROVIDED TO LEVER THE CIRCUIT BREAKER FROM TEST OR CONNECTED POSITIONS. CORRECT OPERATION OF SOME OF THE INTERLOCKS IS DEPENDENT ON USE OF THE PROVIDED LEVERING CRANK. PERSONAL INJURY OR EQUIPMENT DAMAGE COULD RESULT FROM THE USE A TOOL OTHER THAN THE PROPER LEVERING-IN CRANK.

NOTICE

The circuit breaker and integral levering mechanism includes all necessary interlocks that when interfaced with a compatible structure will render the circuit breaker mechanism mechanically and electrically trip-free during the levering process. For information pertaining to individual interlocks, refer to paragraph 4-9 in this section.

To move the circuit breaker to the CONNECTED position, engage the levering-in crank with the structure mounted levering shaft (Figure 4-6). Turn the levering-in crank in a clockwise direction and the circuit breaker will move slowly toward the rear of the structure. When the circuit breaker reaches the CONNECTED position, it will become impossible to continue turning the levering-in crank. The CONNECTED position will also be indicated by a red flag indicator just below the levering device. If a spin-free levering-in crank is being used, it will spin free once the CONNECTED position is reached. Secondary contacts will automatically engage if not already engaged manually in the TEST position.

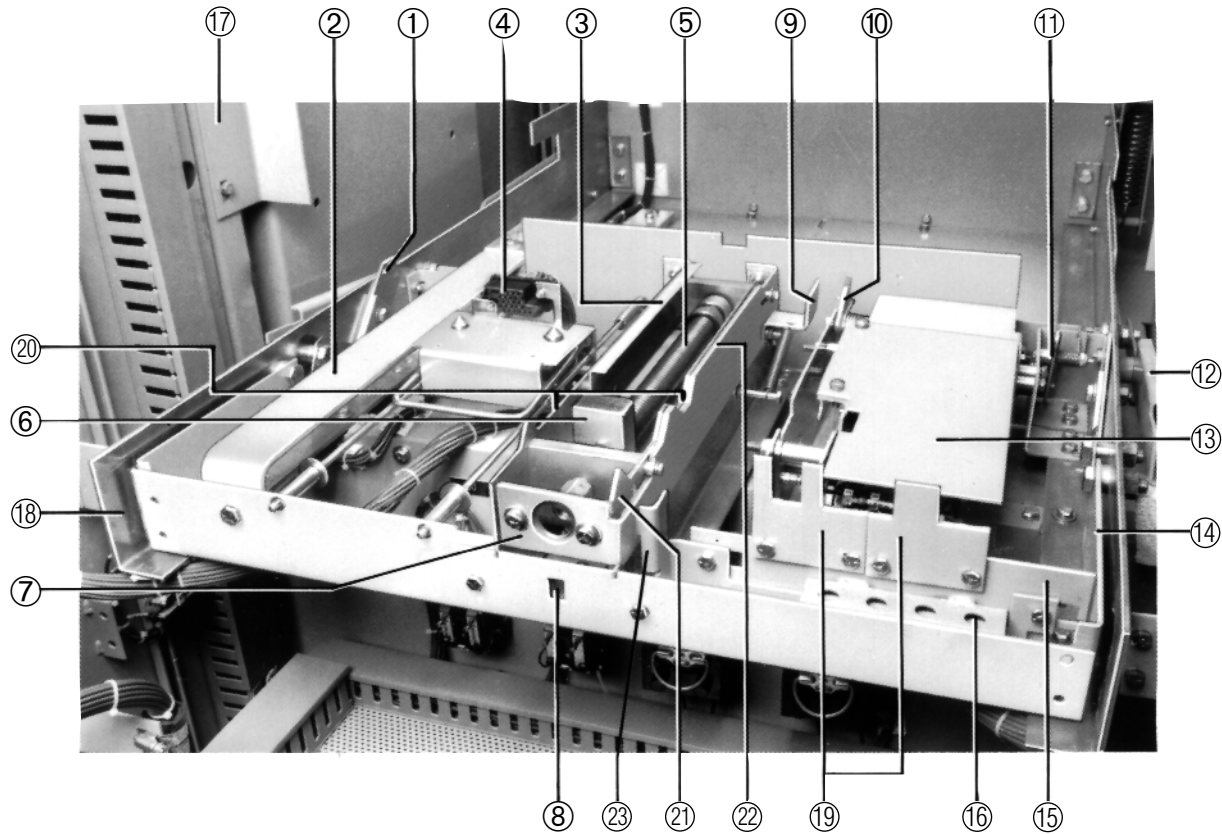

- | | |
|---|--|
| ① Extension Rail Interlock | ⑪ TOC Switch Operator |
| ② Ground Contact | ⑫ Shutter Operator (Manual) |
| ③ Breaker Position Withdrawal Interlock | ⑬ MOC Switch Cover |
| ④ Secondary Disconnect | ⑭ Extension Rail Guide |
| ⑤ Levering Screw | ⑮ Code Plate Mounting Bracket |
| ⑥ Levering Nut (Test/Disc Position) | ⑯ Padlock Openings |
| ⑦ Levering Socket Engagement Interlock (Slider) | ⑰ Picture Frame |
| ⑧ Breaker Connected Position Indicator Opening | ⑱ Code Plates (Power Rating Interlock) |
| ⑨ Positive Interlock | ⑳ Maintenance Interlock |
| ⑩ MOC Switch Operator | ㉑ Levering Interlock |
| | ㉒ Negative and Position Closing Interlocks |
| | ㉓ Padlock/Key Lock Operator |

Figure 4-2 Typical VCP-W Circuit Breaker Compartment

To remove the circuit breaker from the structure, reverse the procedure just described by turning the levering-in crank in a counterclockwise direction. Keep in mind that safety interlocks may cause the circuit breaker to open and/or springs to discharge during the removal process. It depends on what condition the circuit breaker was in as removal began.

For additional information on the levering mechanism, refer to paragraph 5-6 in this manual.

4-8.2 OPERATION CHECK PERFORMANCE

Move the circuit breaker to the TEST position and engage the secondary contacts following the procedure described in paragraph 4-8.1. As soon as the closing springs are charged, the condition will be indicated by a Spring Charged/Discharged Indicator on the front of the circuit breaker (Figure 3-5). In addition, the status of the main contacts, open or closed, is indicated on the front of the circuit breaker.

Close and trip the circuit breaker several times to verify closing and tripping operations. Conclude by closing the circuit breaker. The circuit breaker is now closed in the TEST position with springs charged.



Figure 4-3 Engaging Extension Rails in a Lower Circuit Breaker Compartment

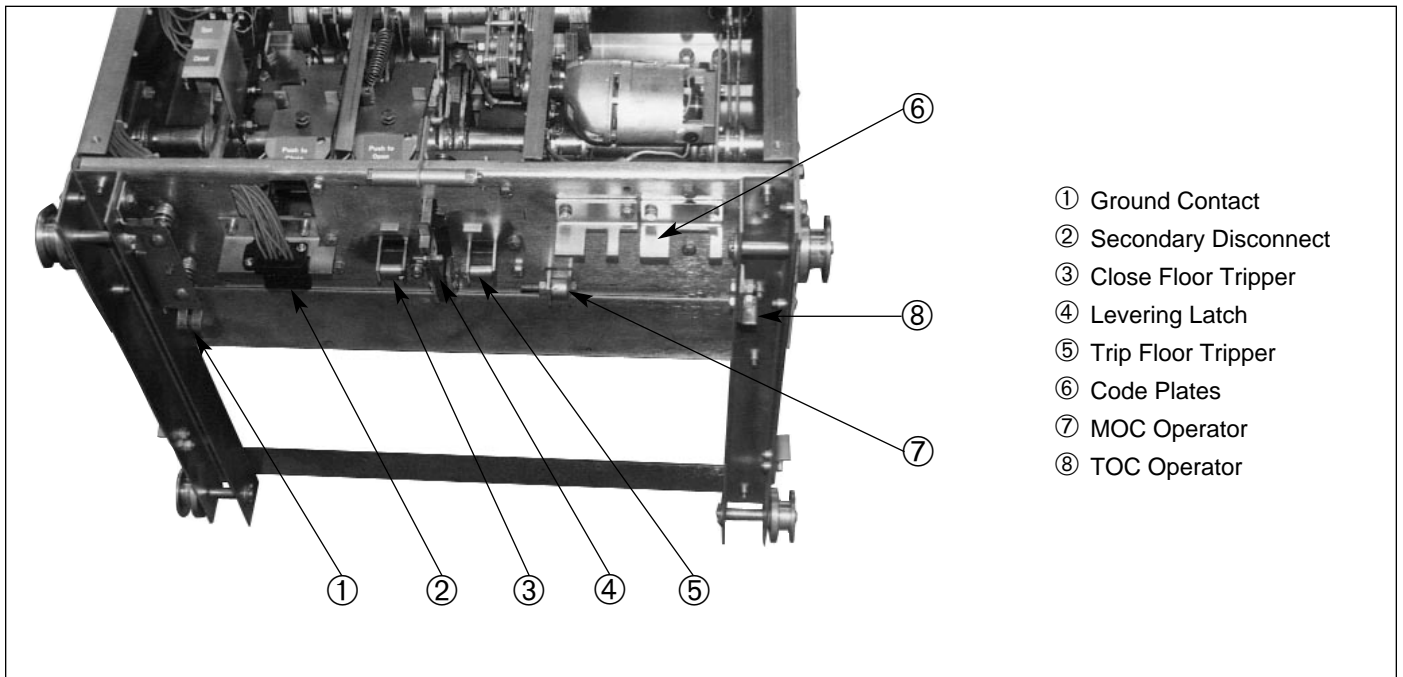

- ① Ground Contact
- ② Secondary Disconnect
- ③ Close Floor Tripper
- ④ Levering Latch
- ⑤ Trip Floor Tripper
- ⑥ Code Plates
- ⑦ MOC Operator
- ⑧ TOC Operator

Figure 4-4 Typical VCP-W Circuit Breaker Bottom View

4-9 CIRCUIT BREAKER/STRUCTURE INTERFACING



WARNING

NEVER DISABLE OR DEFEAT ANY INTERLOCKS. THEY ARE INTENDED FOR PROPER AND SAFE OPERATION. FAILURE TO COMPLY COULD RESULT IN DEATH, SEVERE PERSONAL INJURY AND/OR PROPERTY DAMAGE DUE TO THE HAZARDOUS VOLTAGE PRESENT.

Type VCP-W Circuit Breakers are supplied with a series of interlocks to insure safe and proper interfacing between the circuit breaker and its compartment. Specific interlocks are described in the next paragraph to provide proper familiarization. An interfacing check should be performed as also described in the next paragraph.

4-9.1 INTERFACE INTERLOCKS/INTERFACING CHECK

Refer to Figures 3-5, 4-2 and 4-4 for visual interlock and interface check references. The following interlocks are provided to ensure safe and proper operation:

Code Plates

Code plates are provided to prevent the insertion of a circuit breaker into a structure of a higher power rating. Compatible plates on the circuit breaker and in the compartment form this interlock.

NOTICE

Code plates do not block out control voltage or scheme incompatibility.

Maintenance Interlock

This interlock trips, closes and trips the circuit breaker if it is closed and charged as the circuit breaker from the TEST position to the extension rails and vice versa. The circuit breaker open and closing springs are, therefore, discharged.

Levering Interlock

If the circuit breaker is closed as the levering-in crank is engaged to move the circuit breaker from the TEST to the CONNECTED position, the circuit breaker trips.



Figure 4-5 Pulling Secondary Disconnect Cage to Engage Secondaries in TEST Position



Figure 4-6 Engaging Levering-In Crank

Positive Interlock

The positive interlock prevents the levering-in crank from being engaged if the circuit breaker is closed in the CONNECTED position.

Negative Interlock

The negative interlock prevents the circuit breaker from closing between the CONNECTED and TEST positions.

Position Closing Interlock

The circuit breaker is prevented from closing automatically when it is moved from the TEST to the CONNECTED position if the closing switch is maintained during the levering-in operation.

Position Withdrawal Interlock

This interlock prevents the circuit breaker from being withdrawn by pulling unless it is in the TEST position.

Extension Rail Interlock

The extension rail interlock prevents the circuit breaker from being withdrawn out of its compartment unless the extension rails are properly engaged to the fixed rails.

The correct operation of provided interlocks should be confirmed. Keep in mind that an interfacing check is made with a compatible structure. As such, the instructions provided here may overlap with the instructions provided with the assembly. In any case, all provided interlocks should be confirmed. Review paragraph 4-8.1 before proceeding if additional instructions are needed on insertion and removal of a circuit breaker.

At the conclusion of the operations check as described in paragraph 4-8.2, the circuit breaker was closed in the TEST position with its springs charged. Engage the levering-in crank. The circuit breaker will automatically trip and MOC switches will operate if the circuit breaker compartment is equipped with MOC switches designed to operate in the TEST position.

Lever the circuit breaker towards the CONNECTED position. As the circuit breaker moves, protective compartment shutters will automatically begin to open uncovering fixed primary contacts. TOC switches will also operate once the CONNECTED position is

reached, if TOC switches are provided in the structure. Remove the levering-in crank at this point.

Close the circuit breaker. Any provided MOC switches will operate and the motor closing springs will charge if control power is available.

Attempt to engage the levering crank. The slider cannot be pushed far enough to engage the levering-in crank. Trip the circuit breaker, engage the levering-in crank, and lever the circuit breaker out approximately halfway towards the TEST position.

Attempt to lift the circuit breaker lift/pull handle to pull the circuit breaker out. The position withdrawal interlock will prevent lifting the handle high enough to disengage the levering latch from the nut. This prevents the circuit breaker from being pulled out.

Attempt to close the circuit breaker by pushing the manual close button. The circuit breaker will go trip free (springs discharge but circuit breaker will not close). Lever the circuit breaker to the TEST position. The secondary contacts will disengage automatically.

Engage the secondary contacts by pulling them forward as far as possible. Close the circuit breaker. The motor will start charging the springs automatically.

Remove the extension rails. Disengage the levering latch by lifting the handle on the circuit breaker and attempt to pull the circuit breaker out. The circuit breaker will not move out more than two inches beyond the TEST position. Push the circuit breaker back to the TEST position. Engage the extension rails. Once again disengage the levering latch and pull the circuit breaker out. The circuit breaker will trip, close and trip as it comes out on to the extension rails from the TEST position.

NOTICE

The interface checks outlined in this manual and the manual provided with the assembly structure are intended to verify safe and proper operation. If observed conditions are not as described, contact Cutler-Hammer for assistance.

SECTION 5: DESCRIPTION AND OPERATION

5-1 INTRODUCTION

Type VCP-W, VCPW-SE and VCPW-ND vacuum circuit breakers are horizontal drawout designs for use in metal-clad switchgear compartments. Most ratings can be stacked two high in a vertical section resulting in a considerable savings of floor space.

Vacuum interrupters are used with all circuit breakers to close and open the primary circuit. All VCP-W circuit breakers are operated by a front mounted spring type stored energy mechanism (Figure 3-3). The stored energy mechanism is normally charged by an electric motor, but can be charged manually with the manual maintenance tool. Since the same basic, front accessible mechanism is used for all VCP-W circuit breakers, a minimum investment in spare parts is required.

The primary insulation used with Type VCP-W circuit breakers is flame retardant and track resistant glass polyester except for the Type VCPW-SE circuit breaker. The VCPW-SE special environment circuit breaker design utilizes cycloaliphatic epoxy for its primary insulation. "Fast On" type secondary control terminations are used on Types VCP-W and VCPW-ND circuit breakers, while the Type VCPW-SE circuit breaker utilizes ring type secondary control terminations.

The rest of this section describes the overall operation of the VCP-W circuit breaker as well as the function and operation of all major sub-assemblies and/or parts. Keep in mind that VCP-W will be used throughout the text when referring to any one of the three types of circuit breakers, unless there is a specific difference between VCP-W, VCPW-SE and VCPW-ND.

5-2 INTERRUPTER ASSEMBLY

Vacuum interrupters are mounted vertically and supported from the fixed stem which is clamped to the top conductor. The exclusive current transfer system consists of a series of plated, high-conductivity copper leaf conductors that are pressed on the movable interrupter stem. This design provides a multipoint contact resulting in low electrical and thermal resistance. Utilizing this non-sliding current transfer system between the movable stem and the breaker main conductor eliminates the need for maintenance (Figure 5-1). Multiple finger, floating type primary disconnecting contacts at the ends of the top and bottom conductors provide a means for interfacing with the primary conductors mounted in the switchgear (Figure 3-4).

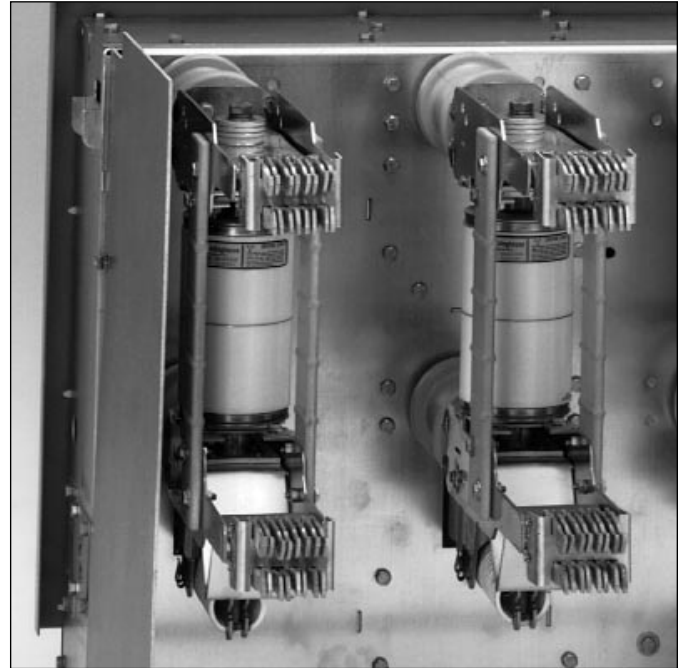

Figure 5-1 Typical VCP-W Rear View Showing Vacuum Interrupters and Current Carrying System

Direct acting insulated operating rods in conjunction with the circuit breaker's mechanism provide a fixed amount of interrupter movable stem motion. This motion is directly related to the interrupter's "Wipe" and "Stroke," each of which is discussed in detail later in this section.

5-2.1 VACUUM INTERRUPTER

Type VCP-W Vacuum Circuit Breakers utilize vacuum interrupters for interruption and switching functions. The vacuum interrupters use petal type copper chrome contacts for superior dielectric strength, better performance characteristics, and lower chop current. Vacuum interruption provides the advantages of enclosed interrupters, reduced size and weight, short interrupting time, long life, reduced maintenance, and environmental compatibility.

Arc interruption is simple and fast (Figure 5-2). In the closed position, current flows through the interrupter. When the contacts are opened, the arc is drawn between the contact surfaces. It is moved rapidly around the slotted contact surfaces by a self-induced magnetic force which prevents gross contact erosion as well as the formation of hot spots on contact surfaces. The arc burns in an ionized metal vapor which continually leaves the contact area and condenses on the surrounding metal shield.

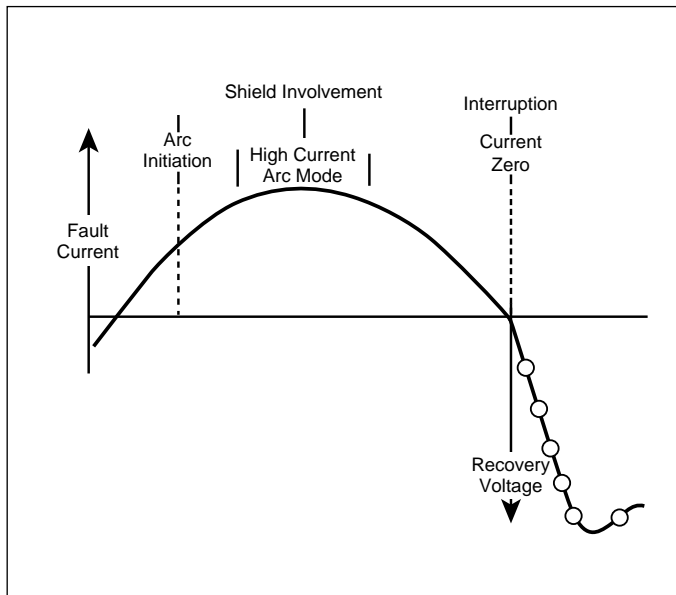

Figure 5-2 Graphic Representation of Arc Interruption

At current zero, the arc is extinguished and vapor production ceases. Very rapid dispersion, cooling, recombination, and deionization of the metal vapor plasma, together with the fast condensation of metal vapor products, cause the vacuum to be quickly restored. Hence, the opened contacts withstand the transient recovery voltage.

5-2.2 CONTACT EROSION INDICATION

The purpose of a contact erosion indicator is to monitor the erosion of the vacuum interrupter contacts, which is very minimal over time with vacuum interrupters utilizing copper-chrome contact material. If contact erosion reaches 1/8 inch, the interrupter must be replaced. A green contact erosion indicator mark is located on the moving stem of the interrupter (Figures 6-2 and 6-3).

In order to determine if the contacts have eroded to the extent that the interrupter must be replaced, observe the erosion mark placed on each moving stem from the rear of the breaker with the breaker closed. The interrupter is satisfactory if the mark on the stem is visible with the breaker closed. The entire interrupter assembly must be replaced if the mark is no longer visible.

5-2.3 LOADING SPRING INDICATOR

The loading spring indicator is an additional method provided to indicate conditions within the interrupter. The indicator is used to indicate whether the contact springs

are maintaining the adequate contact pressure to keep the contacts closed. Severe contact erosion would result in an unacceptable indication from the indicator (Figure 6-4). Depending upon the structural design, a small mirror may be required to inspect all three poles.

Note that the actual configuration and/or appearance of the indicator can vary from one circuit breaker rating to another. The actual appearance of the indicator depends upon the color of the contact springs in a specific circuit breaker. When making this inspection, first observe the color of the contact springs to determine how the indicator will appear. Figure 6-4 illustrates what the actual indicator appearance will be, depending upon the color of the springs.

5-2.4 CONTACT WIPE AND STROKE

Contact wipe is the indication of (1) the force holding the vacuum interrupter contacts closed and (2) the energy available to hammer the contacts open with sufficient speed for interruption.

Stroke is the gap between fixed and moving contacts of a vacuum interrupter with the circuit breaker open.

The circuit breaker mechanism provides a fixed amount of motion to the operating rods. The first portion of the motion is used to close the contacts (i.e. stroke) and the remainder is used to further compress the preloaded wipe spring. This additional compression is called wipe. Wipe and Stroke are thus related to each other. As the stroke increases due to the erosion of contacts, the wipe decreases. A great deal of effort has been spent in the design of all VCP-W vacuum circuit breakers in order to eliminate the need for field adjustments of wipe or stroke.



CAUTION

THERE IS NO PROVISION FOR IN-SERVICE ADJUSTMENTS OF CONTACT WIPE AND STROKE. ALL SUCH ADJUSTMENTS ARE FACTORY SET AND SHOULD NOT BE ATTEMPTED IN THE FIELD.

5-2.5 PHASE BARRIERS

Phase barriers on all VCP-W circuit breakers are made of glass polyester. Table 5.1 gives the number and configuration of the barriers required for each circuit breaker rating.

Table 5.1 VCP-W Circuit Breaker Barrier Configurations

ANSI Breaker Identification	Amps	Approximate Vacuum Interrupter Diameter-Inches	Number of Barriers
50VCPW-ND250	1200	4	0
50VCP-W250	1200 2000 3000	4 5 7	2 4 2 + 2 in cell
50VCP-W350	1200 2000 3000	7 or 5 7 or 5 7	2 + 2 in cell 2 + 2 in cell 2 + 2 in cell
75VCP-W500	1200 2000 3000	5 or 4 5 7	4 or 2 4 2 + 2 in cell
150VCP-W500	1200 2000 3000	4 or 3 5 7	2 4 2 + 2 in cell
150VCP-W750	1200 2000 3000	4 5 7	2 4 2 + 2 in cell
150VCP-W1000	1200 2000 3000	7 or 5 7 or 5 7	2 + 2 in cell 2 + 2 in cell 2 + 2 in cell
150VCP-W63	1200 2000 3000	7 7 7	2 + 2 in cell 2 + 2 in cell 2 + 2 in cell
270VCP-W	630 1200 2000	4 4 or 5 5	2 + 2 in cell 2 + 2 in cell 2 + 2 in cell

Number of Barriers — Key

- 2.....Two phase-to-ground barriers on the breaker.
- 4.....Two phase-to-ground and two phase-to-phase barriers on the breaker.
- 2 + 2 in cell.....A group of two or two separate barriers on the breaker and two exterior barriers mounted on the sides of the cell.

Note: Although only standard ANSI rated VCP-W breakers are given in these configurations, all VCPW-SE and IEC rated breakers follow the same barrier configurations based on the diameter of the vacuum interrupter.



WARNING

DO NOT PLACE THE CIRCUIT BREAKER IN ITS COMPARTMENT WITHOUT THE PHASE BARRIERS IN PLACE. THE ABSENCE OF THE BARRIERS COULD CAUSE A CATASTROPHIC FAILURE DURING INTERRUPTION OR OPERATION RESULTING IN DEATH, SEVERE PERSONAL INJURY AND/OR PROPERTY DAMAGE.

The multiple finger primary disconnect contacts are silver plated and waxed. In order to provide visual indication of the presence of wax, a blue dye is added during the waxing process to give a bluish color to the disconnect contacts. The wax acts as a conductive lubricant without attracting dirt. For this reason the contacts do not require any additional lubricant.

5-3 STORED ENERGY MECHANISM



WARNING

KEEP HANDS AND FINGERS AWAY FROM THE CIRCUIT BREAKER'S INTERNAL PARTS WHILE THE CIRCUIT BREAKER CONTACTS ARE CLOSED OR THE CLOSING SPRINGS ARE CHARGED. THE CIRCUIT BREAKER CONTACTS MAY OPEN OR THE CLOSING SPRINGS DISCHARGE CAUSING A CRUSHING INJURY. DISCHARGE THE SPRINGS AND OPEN THE CIRCUIT BREAKERS BEFORE PERFORMING ANY CIRCUIT BREAKER MAINTENANCE, INSPECTION OR REPAIR.

The spring stored energy operating mechanism is arranged vertically in front of all VCP-W circuit breakers (Figure 3-3). It includes all the elements for storing the energy, closing and tripping of the circuit breaker, as well as manual and electrical controls. The manual controls are all front accessible. Motion to close and open the interrupter contacts is provided through operating rods connecting the mechanism pole shaft to the bell cranks of the interrupter assemblies.

5-3.1 OPERATION OF STORED ENERGY MECHANISM

The mechanism stores the closing energy by charging the closing springs. The mechanism may rest in any one of the four positions shown in Figure 5-3 and as follows:

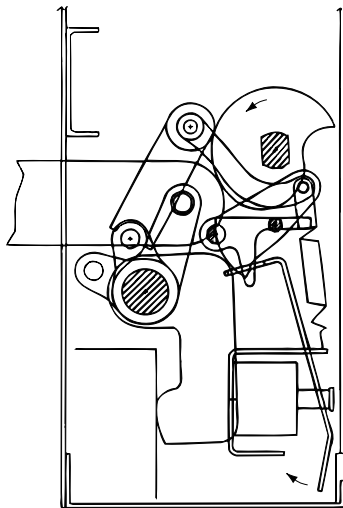

Figure 5-3a Breaker open and closing spring discharged.

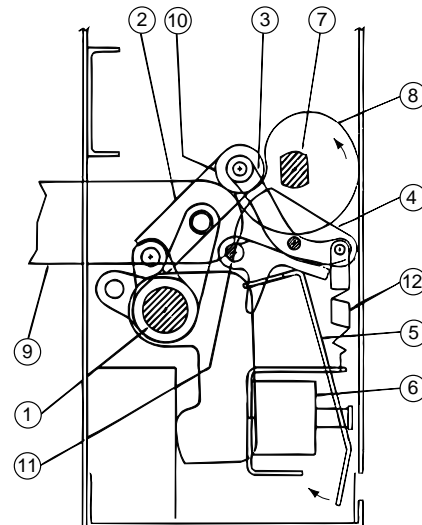

Figure 5-3b Breaker open and closing spring charged.

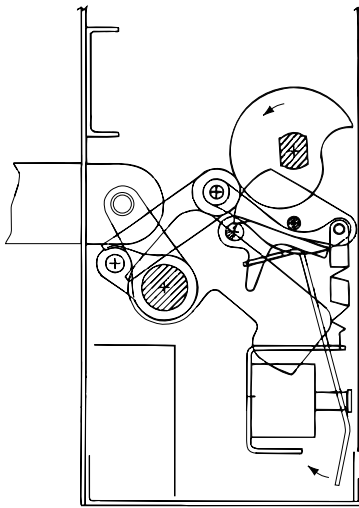

Figure 5-3c Breaker closed and closing spring discharged

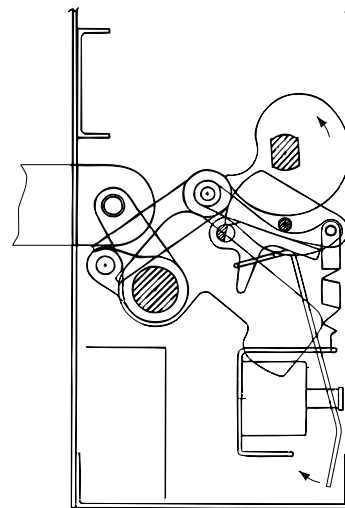
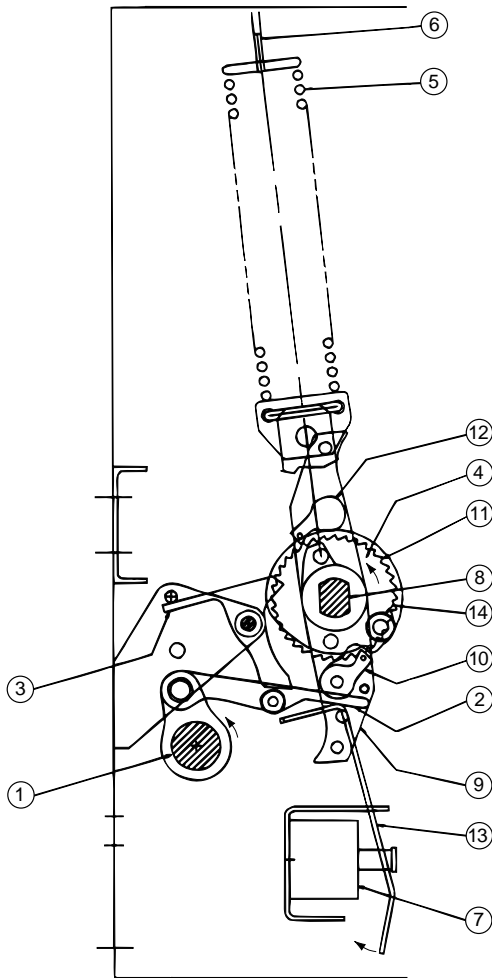

Figure 5-3d Breaker closed and closing spring charged

- | | | |
|---------------|--------------------|---------------------------|
| ① Pole Shaft | ⑤ Shunt Trip Lever | ⑨ Operating Rod |
| ② Main Link | ⑥ Shunt Trip Coil | ⑩ Main Link Roller |
| ③ Banana Link | ⑦ Cam Shaft | ⑪ Trip Bar "D" Shaft |
| ④ Trip Latch | ⑧ Closing Cam | ⑫ Trip Latch Reset Spring |

Figure 5-3 Closing Cam and Trip Linkage



Breaker Open, Springs Discharged

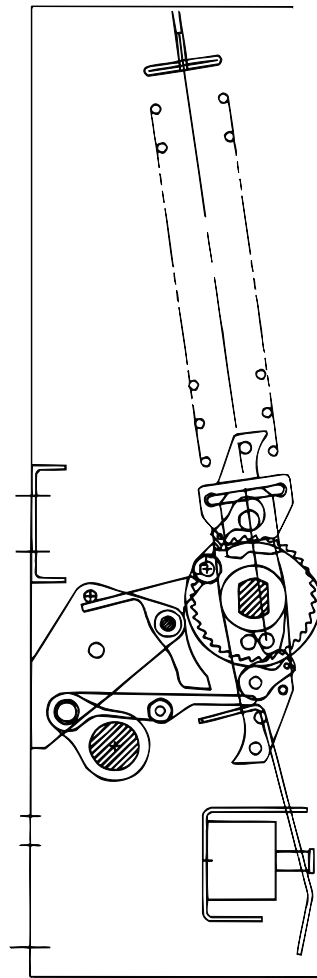

Breaker Closed, Springs Charged

- | | |
|---|--|
| <ul style="list-style-type: none"> ① Pole Shaft ② Anti-Close Interlock ③ Spring Release (Close) Latch ④ Spring Crank ⑤ Closing Spring ⑥ Closing Spring Fixed End ⑦ Spring Release (Close) Coil | <ul style="list-style-type: none"> ⑧ Cam Shaft ⑨ Motor Ratchet Lever ⑩ Drive Pawl ⑪ Ratchet Wheel ⑫ Holding Pawl ⑬ Spring Release (Close) Clapper ⑭ Spring Release Latch (Close Roller) |
|---|--|

Figure 5-4 Charging Schematic

- Breaker element open, closing springs discharged
- Breaker element open, closing springs charged
- Breaker element closed, closing springs discharged
- Breaker element closed, closing springs charged

5-3.2 CHARGING

Figure 5-4 is a schematic view of the spring charging parts of the stored energy mechanism.

The major component of the mechanism is a cam shaft assembly which consists of a drive shaft to which are attached two closing spring cranks (one on each end), the closing cam, drive plates, and a free-wheeling ratchet wheel. The ratchet wheel is actuated by an oscillating mechanism driven by the motor eccentric. As the ratchet wheel rotates, it pushes the drive plates which in turn rotate the closing spring cranks and the closing cam with it.

The closing spring cranks have spring ends connected to them, which are in turn coupled to the closing springs. As the cranks rotate, the closing springs are charged. When the closing springs are completely charged, the spring cranks go over dead center, and the closing stop roller comes against the spring release latch. The closing springs are now held in the fully charged position.

Closing springs may also be charged manually. Insert the maintenance tool in the manual charging socket. Move it up and down approximately 38 times until a clicking sound is heard, and the closing springs charging indicator indicates "Charged." Any further motion of the maintenance tool will result in free wheeling of the ratchet wheel.

5-3.3 CLOSING OPERATION

Figure 5-3 shows the position of the closing cam and tripping linkage. Note that in Figure 5-3a in which the circuit breaker is open and the closing springs are discharged, the trip "D" shaft and trip latch are in the unlatched position.

Once charged, the closing springs can be released to close the circuit breaker by moving the spring release latch out of the way. This is done electrically or manually by depressing the spring release lever, which turns the spring release latch out of the way of the closing stop roller. The force of the closing spring rotates the cam shaft through the spring cranks. The closing cam, being attached to the cam shaft, in turn rotates the pole shaft through the main link to close the circuit breaker.

In Figure 5-3c the linkage is shown with the circuit

breaker in the closed position before the closing springs have been recharged. Interference of the trip "D" shaft with the trip latch prevents the linkage from collapsing, and the circuit breaker is held closed.

Figure 5-3d shows the circuit breaker in the closed position after the closing springs have been recharged. Note that the spring charging rotates the closing cam by one half turn. Since the cam surface in contact with the main link roller is cylindrical in this region, the spring charging operation does not affect the mechanism linkage.

Since the primary contacts are completely enclosed in the vacuum interrupter and not adjustable in any way, a "Slow Close" capability is not provided with VCP-W circuit breakers.

5-3.4 TRIPPING OPERATION

When the trip "D" shaft is turned either by the trip button or trip coil, all links return to the original "open" condition shown in Figure 5-3a.

5-3.5 TRIP FREE OPERATION

When the manual trip button is held depressed, any attempt to close the circuit breaker results in the discharge of the closing springs without any movement of the pole shaft or vacuum interrupter stem.

5-4 CONTROL SCHEMES

There are two basic control schemes for VCP-W circuit breakers, one for DC control and one for AC control voltages (Figure 5-5). There may be different control voltages or more than one tripping element, but the principal mode of operation is as follows:

As soon as the control voltage is applied, the spring charging motor automatically starts charging the closing springs. When the springs are charged, the motor cut off LS1/bb switch turns the motor off. The circuit breaker may be closed by making the control switch close (CS/C) contact. Automatically upon closing of the circuit breaker, the motor starts charging the closing springs. The circuit breaker may be tripped at any time by making the control switch trip (CS/T) contact.

Note the position switch (PS1) contact in the spring release circuit in the scheme. The contact remains made while the circuit breaker is being levered between the TEST and CONNECTED positions. Consequently, it prevents the circuit breaker from closing automatically, even though the control close contact (CS/C) may have

ANSI STANDARD VCP-W BREAKER DC CONTROL SCHEMATIC '96

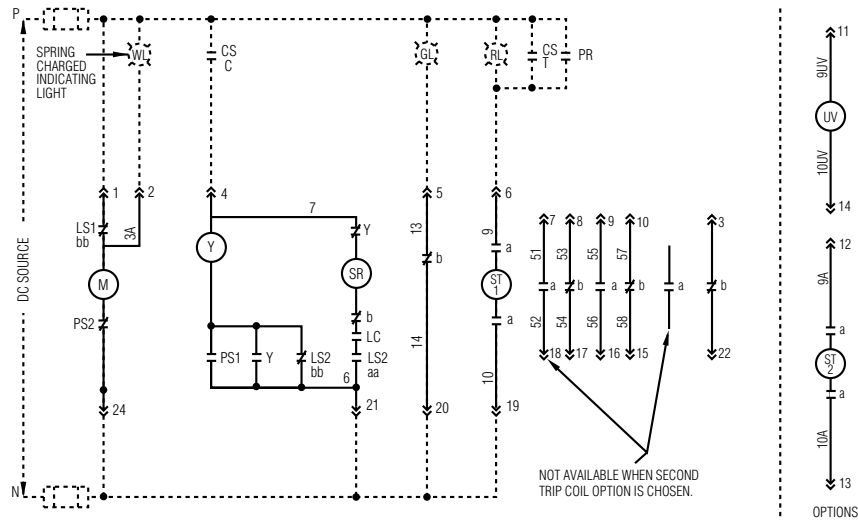

ANSI STANDARD VCP-W BREAKER AC CONTROL SCHEMATIC '96

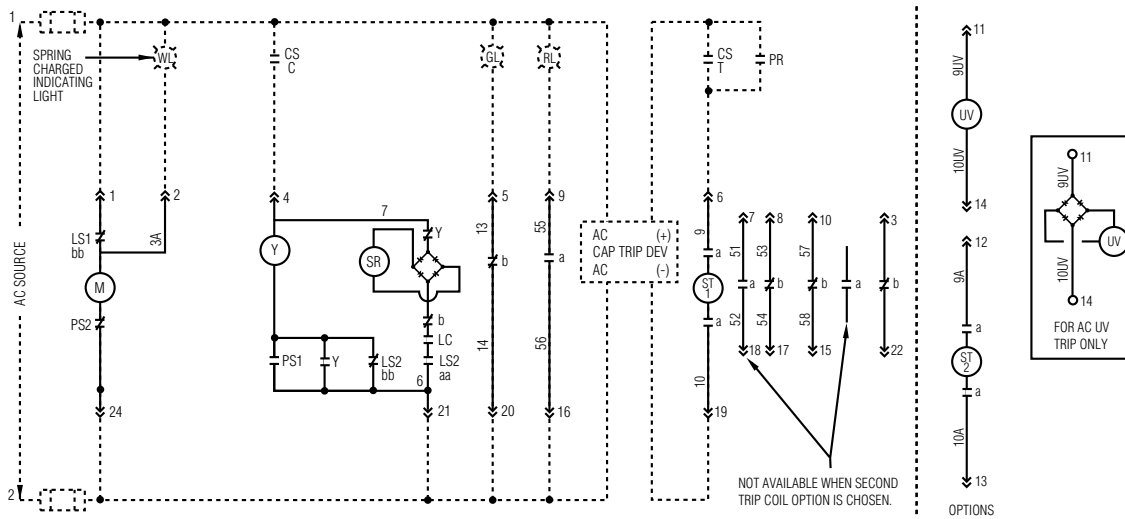

- CS - Breaker Control Switch - close
- C - Breaker Control Switch - trip
- Y - Anti Pump Relay
- SR - Spring Release Coil (Close Coil)
- M - Spring Charging Motor
- ST - Shunt Trip Coil
- PR - Protective Relay
- ≡ - Secondary Disconnect

- OPERATION**
- LS1 bb - Closed until springs are fully charged
 - LS2 aa - Open until springs are fully charged
 - LS2 bb - Closed until springs are fully charged
 - LC - Open until mechanism is reset
 - PS1 - Open in all except between TEST and CONNECTED Positions
 - PS2 - Closed in all except between TEST and CONNECTED Positions

- SWITCH TERMINAL**
- 'C' and 'NO' - Brown Switch
 - 'C' and 'NC' - Black Switch
 - 'C' and 'NO' - Black Switch
 - 'C' and 'NC' - Black Switch
 - 'C' and 'NO' - Black Switch
 - 'C' and 'NO' - Black Switch

Figure 5-5 Typical VCP-W DC and AC Control Schemes

Table 5.2 Circuit Breaker Timing

Event	Milliseconds (maximum)
Closing Time (From Initiation of Close Signal to Contact Make)	45-60
Opening Time (Initiation of Trip Signal to Contact Break)	30-45
Reclosing Time (Initiation of Trip Signal to Contact Make)	140-165

been made while the circuit breaker is levered to the CONNECTED position.

When the CS/C contact is made, the SR closes the circuit breaker. If the CS/C contact is maintained after the circuit breaker closes, the Y relay is picked up. The Y/a contact seals in Y until CS/C is opened. The Y/b contact opens the SR circuit, so that even though the circuit breaker would subsequently open, it could not be reclosed before CS/C was released and remade. This is the anti-pump function.

5-4.1 TIMING

The opening and closing times for the circuit breakers vary depending upon the control voltage and the power rating. Typical values for VCP-W outdoor breaker elements are shown in Table 5.2.

5-4.2 SECONDARY DISCONNECTS

The circuit breaker control wiring is arranged to connect a standard 25 point male plug with a corresponding switchgear compartment mounted female plug. The circuit breaker plug is fixed mounted on the left side under the bottom pan of the mechanism (Figure 4-4). The female plug is mounted in the compartment on a movable carriage (Figure 4-2).

The secondary disconnects engage automatically as the circuit breaker is levered into the CONNECTED position, and disengage as the circuit breaker is withdrawn from the CONNECTED position. To engage the secondary contacts while the circuit breaker is in the TEST

position, raise the handle and pull the carriage all the way towards the front (Figure 4-5). This will latch the contacts. To disengage the contacts, simply push the carriage to the rear.

5-4.3 UNDERVOLTAGE TRIP DEVICE

The undervoltage trip device for VCP-W circuit breakers is an electromechanical device that operates to open the circuit breaker at 30% or less of the voltage rating of the trip coil. The device does not open the circuit breaker at values above 60% of the voltage rating of its trip coil. It may operate, however, to open the circuit breaker when the voltage across the trip coil is greater than 30%, but less than 60% of the voltage rating of its trip coil. The circuit breaker can be closed as long as the voltage to the trip coil is maintained at 85% or above the rated level. The undervoltage trip device is available only as an instantaneous type with rated voltages of 48VDC, 125VDC, 250VDC, 120VAC and 240VAC.

For a basic understanding of the operation of the undervoltage trip device refer to the specific items identified in Figure 5-6 and the following operation description.

1. With the circuit breaker closed and sufficient voltage on the Undervoltage Trip Device coil, the moving clapper (1) is held to the stationary yoke (2) by the magnetic force produced by the coil (3) against the extension springs (4) pulling the moving clapper apart from the yoke.
2. The moving clapper is connected to the mechanism Trip D Shaft Lever (5) by a slotted link (6).
3. When the voltage to the Undervoltage Trip Coil goes down as described earlier, the extension springs force overcomes the reduced magnetic force and pulls the moving clapper up. The slotted link in turn upsets the Trip D Shaft and the circuit breaker trips open.
4. As the circuit breaker opens, the reset lever (8) connected to the pole shaft lever (7) operates to reset the moving clapper. As long as the circuit breaker remains open, the reset lever holds down the moving clapper to the yoke.
5. When the circuit breaker closes, the reset lever moves away from the moving clapper. If the Undervoltage Trip Device coil has at least 85% of the rated voltage applied, the moving clapper is held to the yoke by the magnetic force, even though the reset lever has moved up.

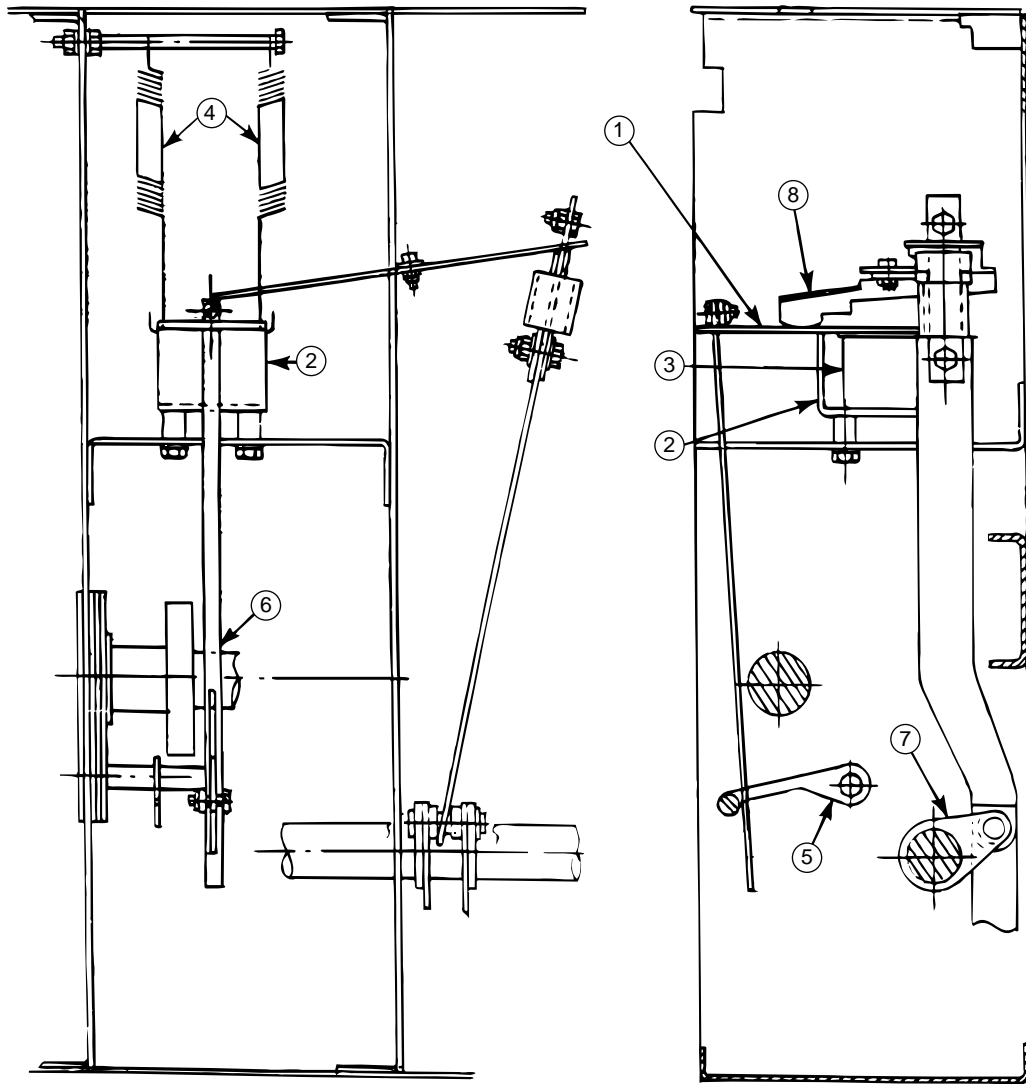

- ① Moving Clapper
- ② Stationary Yoke
- ③ UV Trip Device Coil
- ④ Extension Springs
- ⑤ Trip D Shaft Lever
- ⑥ Slotted Link
- ⑦ Pole Shaft Lever
- ⑧ Reset Lever

Figure 5-6 Undervoltage Trip Device Configuration

5-5 INTERLOCKS AND INTERFACING

Refer to Paragraph 4-9 of this manual for detailed information concerning circuit breaker interlocks and their interfacing with a switchgear structure compartment. In addition, refer to the instruction manual supplied with the switchgear assembly.

5-6 LEVERING MECHANISM

The purpose of the levering device is to move the circuit breaker between the TEST and CONNECTED positions. For Type VCP-W circuit breakers, the device is a drive screw and drive nut. Although the device is mounted in the switchgear compartment, a brief description here will help understand the operation (Figures 4-2 and 4-4). For additional information on the insertion and removal of a circuit breaker from its compartment refer to paragraph 4-8.1 in this manual.

The levering device consists of a drive screw, a drive nut, two side rails and a sliding cage. In the TEST position, the nut is all the way to the front. As the circuit breaker is pushed in, the levering latch snaps on the nut. Turning the crank clockwise while pushing forward advances the circuit breaker toward the CONNECTED position. During this travel, the floor tripper TRIP roller is lifted up holding the circuit breaker trip free. When the circuit breaker reaches the CONNECTED position, the crank cannot be turned any further. A red flag indicates that the circuit breaker is fully engaged.

If the circuit breaker is closed in the CONNECTED position, the slider cannot be pushed forward to permit engagement of the levering crank. After tripping the circuit breaker, the levering crank can be engaged and the circuit breaker withdrawn to the TEST position by turning the levering crank counterclockwise. This position is indicated by no further motion of the crank.

The circuit breaker levering latch can be disengaged only when the circuit breaker is in the TEST position by lifting the latch release. As the circuit breaker is withdrawn, it comes out with the contacts open and the springs discharged because of the floor tripping and spring release interlocks.

5-7 OPERATIONS COUNTER

All circuit breakers are equipped with a mechanical operations counter. As the circuit breaker opens, the linkage connected to the pole shaft lever advances the counter reading by one (Figure 3-3).

5-8 GROUND CONTACT

The ground contact is an assembly of spring loaded fingers providing a disconnectable means for grounding the circuit breaker chassis, after it has been inserted into a switchgear structure. The ground contact is located on the left side of the circuit breaker under the mechanism bottom pan. An extension of the switchgear ground bus is secured to the cell floor in such a position to engage the ground contact automatically, when the circuit breaker is moved into the TEST position. It remains engaged in all other circuit breaker positions within the cell (Figures 4-2 and 4-4).

5-9 MOC AND TOC SWITCH OPERATIONS

The MOC (mechanism operated control) switch operator is coupled to the pole shaft (Figure 4-4). In the TEST and CONNECTED positions of the circuit breaker, the operator aligns directly above the MOC switch bell crank levers in the compartment. As the circuit breaker closes, the operator moves down and pushes the bell crank lever to change the MOC switch contact position. Thus, the MOC switch contacts operate in the same manner as the auxiliary switch contacts in the circuit breaker. Although the MOC switch operator is provided on all circuit breakers, the compartment mounted MOC switches are only provided when specified with the switchgear order.

The TOC (truck operated control) switch operator is mounted inside the right foot of the circuit breaker (Figure 4-4). It operates the TOC switch as the circuit breaker moves to the CONNECTED position in the switchgear compartment.

SECTION 6: INSPECTION, MAINTENANCE AND TROUBLESHOOTING

6-1 INTRODUCTION



WARNING

- DO NOT WORK ON A BREAKER ELEMENT WITH PRIMARY POWER APPLIED.
- DO NOT WORK ON A BREAKER ELEMENT WITH SECONDARY CONTACTS CONNECTED.
- DO NOT WORK ON A BREAKER ELEMENT WITH SPRINGS CHARGED OR CONTACTS CLOSED.
- DO NOT DEFEAT ANY SAFETY INTERLOCKS.
- DO NOT LEAVE MAINTENANCE TOOL IN THE SOCKET AFTER CHARGING THE CLOSING SPRINGS.
- DO NOT STAND LESS THAN ONE METER AWAY FROM THE BREAKER ELEMENT WHEN TESTING FOR VACUUM INTEGRITY.

FAILURE TO FOLLOW ANY OF THESE INSTRUCTIONS MAY CAUSE DEATH, SERIOUS BODILY INJURY, OR PROPERTY DAMAGE. SEE SECTION 2 - SAFE PRACTICES FOR MORE INFORMATION.

6-2 FREQUENCY OF INSPECTION AND MAINTENANCE

Periodic inspections and associated maintenance are essential to the safe and reliable operation of VCP-W Vacuum Circuit Breaker Elements. The inspection frequency and associated maintenance recommended are intended to insure the best possible ongoing service. It is imperative that an established schedule be followed. To establish an exact schedule for a specific installation, use the following guidelines:

1. In a clean, non-corrosive environment, inspect and maintain each circuit breaker element annually or every 500 operations, whichever comes first.
2. For special conditions such as frequent circuit breaker element operation, contaminated environments, and high temperature/humidity conditions, the inspection frequency should be twice a year.
3. Inspect a circuit breaker element every time it interrupts fault current.

4. Follow the steps presented in Paragraph 6-3 entitled "Inspection and Maintenance Procedures" for scheduled programs.
5. Create and maintain a dated permanent record of all inspections, maintenance performed, actions taken, observations made, and measurements taken. Not only will this provide valuable historical information, it can help to establish whether or not the present schedule needs to be adjusted.
6. Perform ongoing visual inspections, when possible, of all equipment on a regular basis. Be alert for an accumulation of dirt in and around the circuit breaker elements, loose hardware or discolored insulation.

6-2.1 QUALIFIED PERSONNEL

For the purpose of operating this type of equipment, only individuals thoroughly trained in the operation of power circuit breakers and associated equipment, and having knowledge of connected loads may be considered to be qualified. Refer to further definitions in the National Electrical Safety Code.

For the purpose of inspecting and maintaining such equipment, a qualified person must also be trained in regard to the hazards inherent to working with electricity and the proper way to perform such work. Such an individual should be able to de-energize, clear and tag circuits in accordance with established safety practices. In addition, these individuals should have access to and be trained in the use of protective equipment, such as rubber gloves and flash clothes.

All personnel should be familiar with and understand the material presented in this instruction manual and other related manuals.

6-2.2 GENERAL TORQUE GUIDELINES

Bolts and screws must be properly torqued. This is especially true if parts and/or accessories are added or replaced. Table 6.1 provides guidelines on torque levels. The table is intended as a general guideline and should be applied in conjunction with the experience and good judgment of the individual performing the work.



CAUTION

OVER TORQUING CAN CAUSE PERMANENT DAMAGE WHILE UNDER TORQUING WILL NOT PROVIDE THE PROPER CLAMPING FORCE AND MAY EVENTUALLY WORK LOOSE.

Table 6.1 Torque Guidelines

Bolt Size	Torque (LB-IN)
8 - 32	24
10 - 32	36
1/4 - 20	72
5/16 - 18	144 (12 lb-ft)
3/8 - 16	300 (25 lb-ft)
1/2 - 13	540 (45 lb-ft)

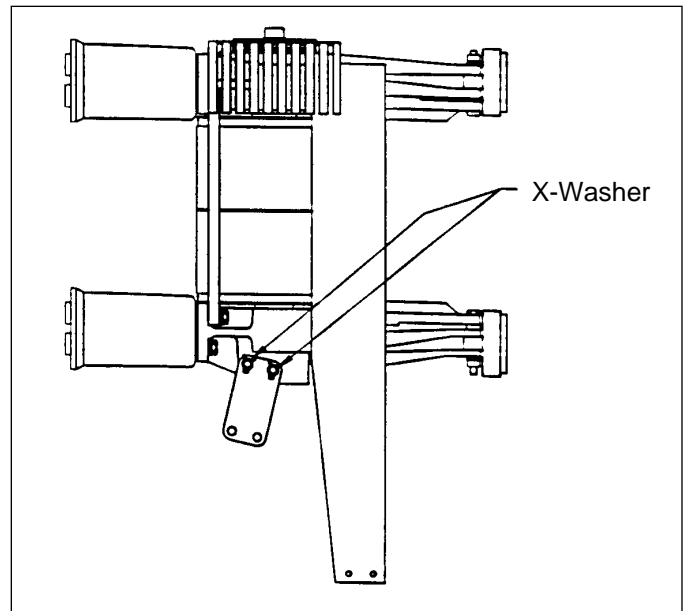

Figure 6-1b 150 VCP-W 63 63kA Pole Unit

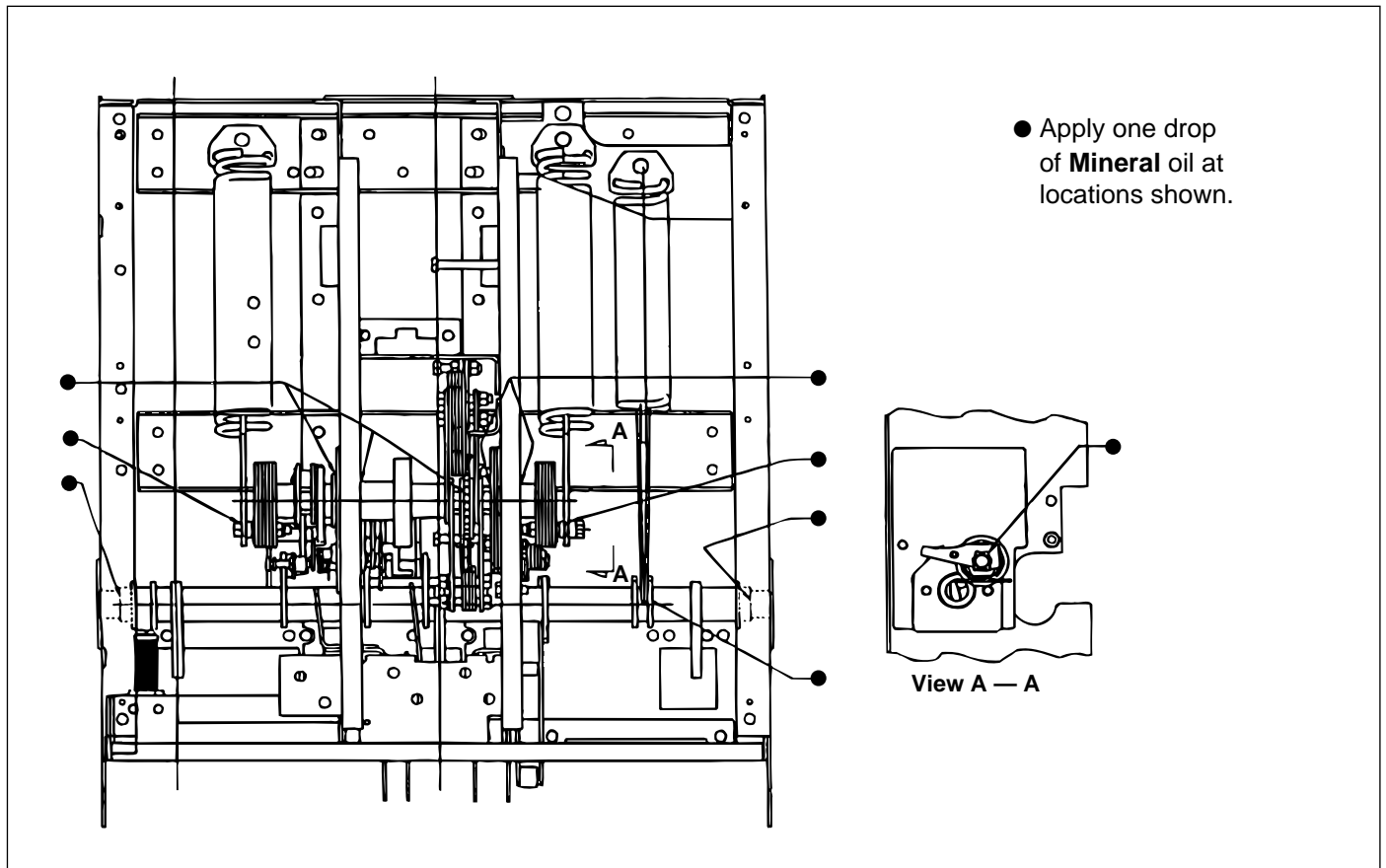

Figure 6-1 Lubrication Points

6-3 INSPECTION AND MAINTENANCE PROCEDURES

No./Section	Inspection Item	Criteria	Inspection Method	Corrective Action	
1. Insulation	Drive Insulator, Barriers, and Stand-off Insulators	No dirt and	Visual Check	Clean with lint-free cloth or	
		No cracking	Visual Check	Replace cracked piece	
	Insulation Integrity	Main Circuit to Ground	Withstand	Hipot Tester	Clean and retest or replace
		Between Main Circuit Terminals	Withstand	Hipot Tester	Clean and retest or replace
	Control Circuit to Ground	Withstand	Hipot Tester	Clean and retest or replace	
2. Power Elements	Vacuum Interrupters	Visibility of contact erosion marks	Visual - Close the circuit breaker and observe if all green marks on moving stems are visible - refer to Paragraph 6-5	If a mark is not visible, proceed to next step and perform contact wipe check	
		Contact wipe indicator visible	Refer to Paragraph 6-5	If not acceptable, perform CloSure Test (6-9.1), replace interrupter assembly if CloSure Test is satisfactory	
		Adequate vacuum	Proceed with integrity check as described in Paragraph 6-4	If integrity check is not satisfactory, replace interrupter assembly	
	Primary Disconnects	Dirt on ceramic body	Visual Check	Clean with lint-free cloth	
		No burning or damage	Visual Check	Replace if burned, damaged or eroded	
	Pole Unit X-Washers for 150 VCP-W 63	Every 1000 operations	Operation counter	Replace all X-Washers per Figure 6-1B	
3. Control Circuit Parts	Closing and Tripping Device Including Disconnects	Smooth and correct operation by control power	Test closing and tripping of the circuit breaker twice	Replace any defective device. Identify per trouble-shooting chart	
	Wiring	Securely tied in proper place	Visual Check	Repair or tie as necessary	
	Terminals	Tight	Visual Check	Tighten or replace if necessary	
	Motor	Smooth, normal operation	Functional Test	Replace brushes or motor	
4. Operating Mechanism	Tightness of Hardware	No loose or missing parts	Visual and by feel	Refer to Table 6.1 and tighten or reinstate if necessary with appropriate tools	
	Dust or Foreign Matter	No dust or foreign matter	Visual Check	Clean as necessary	
	Lubrication	Smooth operation and no excessive wear	Sight, feel and per maintenance schedule	Refer to Figure 6-1 and Paragraph 6-10 and lubricate very sparingly with light mineral oil	
	Deformation or Excessive Wear	No excessive deformation or wear	Visual and operational	Remove cause and replace parts	
	Manual Operation	Smooth operation	Manual charging, closing and tripping	Correct per troubleshooting chart if necessary	
	CloSure Test	≥ 0.6 inch over-travel	CloSure Test (6-9.1)	If < 0.6, contact P.I.C. at (412) 787-6518	

6-4 VACUUM INTERRUPTER INTEGRITY TEST

Vacuum interrupters used in Type VCP-W Vacuum Circuit Breaker Elements are highly reliable interrupting elements. Satisfactory performance of these devices is dependent upon the integrity of the vacuum in the interrupter and the internal dielectric strength. Both of these parameters can be readily checked by a one minute ac high potential test. Refer to Table 6.2 for the appropriate test voltage. During this test, the following warning must be observed:



WARNING

APPLYING ABNORMALLY HIGH VOLTAGE ACROSS A PAIR OF CONTACTS IN VACUUM MAY PRODUCE X-RADIATION. THE RADIATION MAY INCREASE WITH THE INCREASE IN VOLTAGE AND/OR DECREASE IN CONTACT SPACING. X-RADIATION PRODUCED DURING THIS TEST WITH RECOMMENDED VOLTAGE AND NORMAL CONTACT SPACING IS EXTREMELY LOW AND WELL BELOW MAXIMUM PERMITTED BY STANDARDS. HOWEVER, AS A PRECAUTIONARY MEASURE AGAINST POSSIBILITY OF APPLICATION OF HIGHER THAN RECOMMENDED VOLTAGE AND/OR BELOW NORMAL CONTACT SPACING, IT IS RECOMMENDED THAT ALL OPERATING PERSONNEL STAND AT LEAST FOUR METERS AWAY IN FRONT OF THE BREAKER ELEMENT.

With the breaker element open, connect all top primary studs (bars) together and to the high potential machine lead. Connect all bottom studs together and ground them along with the breaker frame. Start the machine at zero potential, increase to appropriate test voltage and maintain for one minute.

A successful withstand indicates that all interrupters have a satisfactory vacuum level. If there is a breakdown, the defective interrupter or interrupters should be identified by an individual test and replaced before placing the breaker in service.



WARNING

AFTER THE HIGH POTENTIAL IS REMOVED, AN ELECTRICAL CHARGE MAY BE RETAINED BY THE VACUUM INTERRUPTERS. FAILURE TO DISCHARGE THIS RESIDUAL ELECTROSTATIC CHARGE COULD RESULT IN AN ELECTRICAL

SHOCK. ALL SIX PRIMARY TERMINALS AND THE CENTER RING OF EACH VACUUM INTERRUPTER OF THE CIRCUIT BREAKER SHOULD BE GROUND-ED TO REDUCE THIS ELECTRICAL CHARGE BEFORE COMING IN CONTACT WITH THE PRIMARY CIRCUIT.

To avoid any ambiguity in the ac high potential test due to leakage or displacement (capacitive) current, the test unit should have sufficient volt-ampere capacity. It is recommended that the equipment be capable of delivering 25 milliamperes for one minute.

Although an ac high potential test is recommended, a dc test may be performed if only a dc test unit is available. In this case the equipment must be capable of delivering 5 milliamperes for one minute. When a DC test voltage is used, a high field emission current from a microscopic sharp spot on one contact can be misinterpreted as a sign of a vacuum interrupter filled with air. To avoid a misinterpreted test result, the open interrupter should always be subjected to both voltage polarities. That is, apply the DC Voltage:

- first, so that one contact of the interrupter is the cathode, and
- second, so that the other contact of the interrupter is the cathode.

A bad interrupter filled with air will have a similarly high leakage current in both polarities. A good interrupter with a good vacuum level may still have a high leakage current, but this will generally be in only one polarity. Such an interrupter usually has a tiny sharp spot on one contact that produces a high field emission current when the sharp spot is a cathode, but not on an anode. In addition, such an interrupter would also normally withstand the required AC voltage which is the definitive test of its vacuum integrity.

Table 6.2 Test Voltage

Breaker Rated Maximum Voltage	Vacuum Interrupter Integrity Test Voltage	
	ac 60 Hz	dc
Up to and including 17.5 kV	27 kV	40 kV
24 kV and 27 kV	45 kV	45 kV

The current delivery capability of 25 ma ac and 5 ma dc apply when all three VIs are tested in parallel. If individual VIs are tested, current capability may be one third of these values.

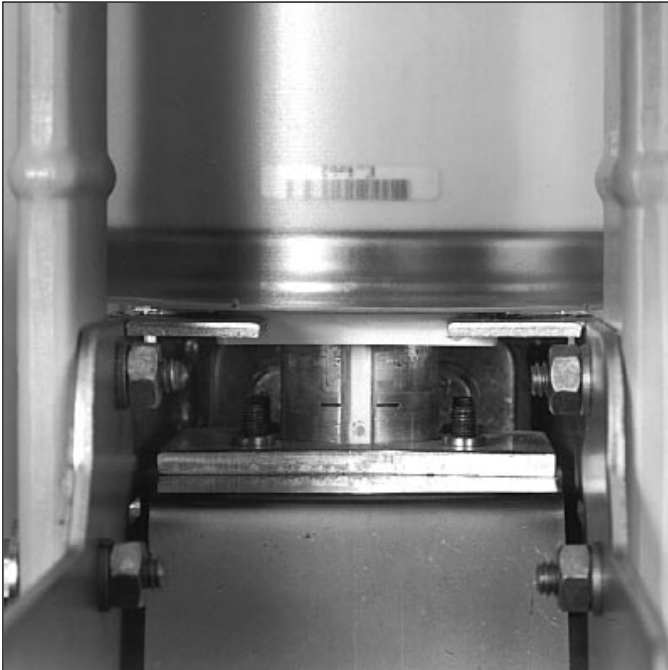

Figure 6-2 Vacuum Interrupter Showing Contact Erosion Indicator with Breaker Open (Shown Here for Clarity Purposes Only)

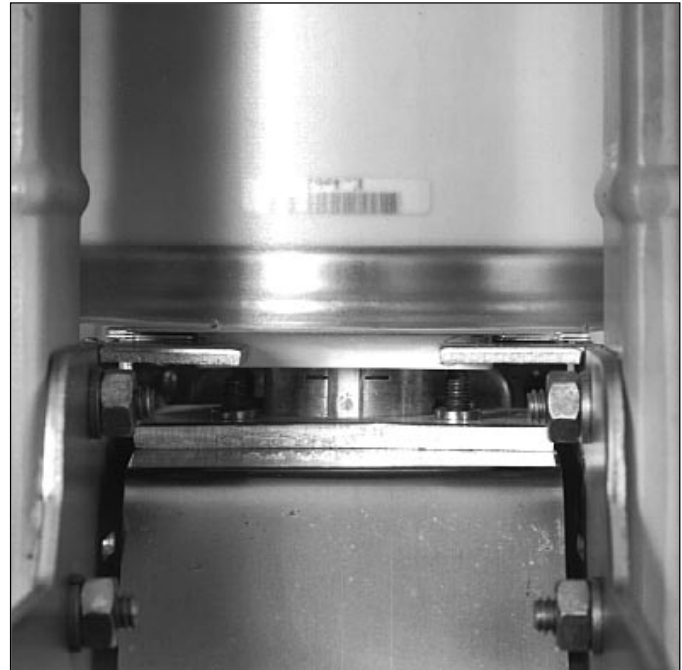

Figure 6-3 Vacuum Interrupter Showing Contact Erosion Indicator with Breaker Closed (Indicators are Checked Only When Breaker is Closed)



CAUTION

SOME DC HIGH POTENTIAL UNITS, OPERATING AS UNFILTERED HALF-WAVE RECTIFIERS, ARE NOT SUITABLE FOR USE TO TEST VACUUM INTERRUPTERS BECAUSE THE PEAK VOLTAGE APPEARING ACROSS THE INTERRUPTERS CAN BE SUBSTANTIALLY GREATER THAN THE VALUE READ ON THE METER.

6-5 CONTACT EROSION AND WIPE

Since the contacts are contained inside the interrupter, they remain clean and require no maintenance. However, during high current interruptions there may be a minimum amount of erosion from the contact surfaces. Maximum permitted erosion is about 1/8 inch. To determine contact erosion, close the breaker and observe the vacuum interrupter moving stem from the rear of the breaker. If the mark on each stem is visible, erosion has not reached maximum value thus indicating satisfactory contact surface of the interrupter. If the mark is not visible, the pole unit assembly must be replaced (Figures 6-2 and 6-3).

The adequacy of contact wipe can be determined by

observing the vacuum interrupter side of the operating rod assembly on a closed circuit breaker. Figure 6-4 shows the procedure for determining the contact wipe. If the wipe is not adequate, the vacuum interrupter assembly (pole unit) must be replaced. A field adjustment is not possible. Refer to paragraph 7-3.2 for a replacement procedure.



WARNING

FAILURE TO REPLACE A POLE UNIT ASSEMBLY WHEN CONTACT EROSION MARK IS NOT VISIBLE OR WIPE IS UNSATISFACTORY, WILL CAUSE THE BREAKER TO FAIL TO INTERRUPT AND THEREBY CAUSE PROPERTY DAMAGE OR PERSONAL INJURY.

6-6 INSULATION

Type VCP-W Circuit Breaker insulation maintenance primarily consists of keeping all insulating surfaces clean. This can be done by wiping off all insulating surfaces with a dry lint free cloth or dry paper towel. In case there is any tightly adhering dirt that will not come off by wiping, it can be removed with a mild solvent or distilled water. Be sure that the surfaces are dry before placing the circuit breaker

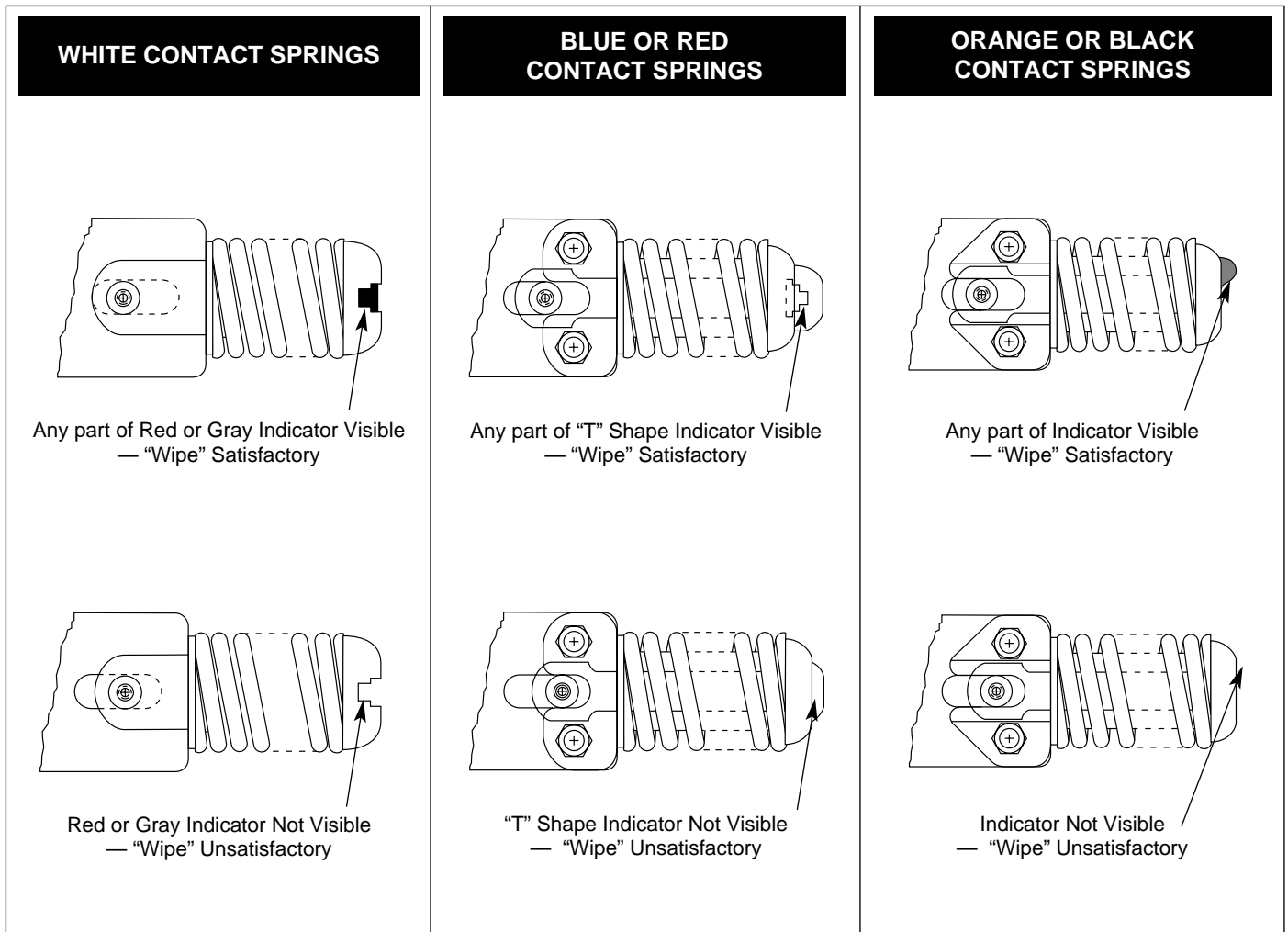

Figure 6-4 Wipe Indication Procedure (Performed Only with Breaker Closed)

in service. If a solvent is required to cut dirt, use Stoddard's Solvent Cutler Hammer 55812CA or commercial equivalent. Secondary control wiring also requires inspection for insulation damage.

6-7 INSULATION INTEGRITY CHECK

Primary Circuit:

The integrity of primary insulation may be checked by the 60Hz AC high potential test. The test voltage depends upon the maximum rated voltage of the breaker. For the breaker elements rated 4.76 kV, 8.25 kV, 15 kV and 27 kV, the test voltages are 15 kV, 27 kV, 27 kV and 45 kV RMS respectively. Conduct the test as follows:

Close the breaker. Connect the high potential lead of the test machine to one of the poles of the breaker. Connect the remaining poles and breaker frame to ground. Start the machine with output potential at zero and increase to the test voltage. Maintain the test voltage for one minute. Repeat for the remaining poles. Successful withstand indicates satisfactory insulation strength of the primary circuit.

If a DC high potential machine is used, make certain that the peak voltage does not exceed the peak of the corresponding AC rms test voltage.

Secondary Circuit:

Isolate the motor by pulling apart the two insulated quick disconnecting terminals in the two motor leads provided for this purpose (Figure 3-3). Connect all points of the

secondary disconnect pins with shooting wire. Connect this wire to the high potential lead of the test machine. Ground the circuit breaker frame. Starting with zero, increase the voltage to 1125 volts rms, 60 Hz. Maintain the voltage for one minute. Successful withstand indicates satisfactory insulation strength of the secondary control circuit. Remove the shooting wire and reconnect motor leads.

6-8 PRIMARY CIRCUIT RESISTANCE CHECK

Since the main contacts are inside the vacuum chamber, they remain clean and require no maintenance at any time. Unlike many typical circuit breaker designs, VCP-W breakers do not have sliding contacts at the moving stem either. Instead they use a highly reliable and unique flexible clamp design that eliminates the need for lubrication and inspection for wear.

If desired, the DC resistance of the primary circuit may be measured as follows: close the circuit breaker, pass at least 100 amps DC current through the circuit breaker. With a low resistance instrument, measure resistance across the studs on the circuit breaker side of the disconnects for each pole. The resistance should not exceed the values shown in Table 6.3.

Table 6.3 Typical Resistance Measurements

Rated Continuous Current (amperes)	Resistance (microohms)
1200	60
2000	40
3000	20

6-9 MECHANISM CHECK

Make a careful visual inspection of the mechanism for any loose parts such as bolts, nuts, pins and rings. Check for excessive wear or damage to the circuit breaker components. Operate the circuit breaker several times manually and electrically. Check the closing and opening times to verify that they are in accordance with the limits in Table 5.2.

6-9.1 CLOSURE™ TEST

Introduction: The CloSure™ Test is a simple yet extremely effective means to determine and monitor the ability of the mechanism to close the breaker contacts fully. It provides a quantitative measure of the extra

energy available in terms of over travel in inches to close the breaker contacts to their full extent. It may be used periodically to monitor the *health* of the mechanism.

At times, circuit breakers are called upon to operate MOC switches (mechanism operated control switches) that place extra load upon the closing mechanism of the circuit breaker. If this load is excessive, it can prevent the circuit breaker from closing fully. In such a case, it is important to determine that the circuit breaker will close fully. The CloSure™ Test provides this assurance.

General Information: The CloSure™ Test can be performed on the VCP-W, VCP-WR, VCPW-ND, DHP-VR, W-VACR, and W-VAC lines of vacuum circuit breakers. Refer to Table 6.4 a for list of circuit breakers. If the CloSure™ travel obtained is as specified, the mechanism performance is satisfactory. If the CloSure™ travel does not conform as shown in Figure 6-12, contact Cutler-Hammer for further information. (See Step 13).



WARNING

DO NOT ATTEMPT TO INSTALL OR PERFORM MAINTENANCE OR TESTS ON THE EQUIPMENT WHILE IT IS ENERGIZED. NEVER PUT YOUR HANDS NEAR THE MECHANISM WHEN THE CIRCUIT BREAKER IS IN THE CHARGED OR CLOSED POSITION. DEATH OR SEVERE PERSONAL INJURY

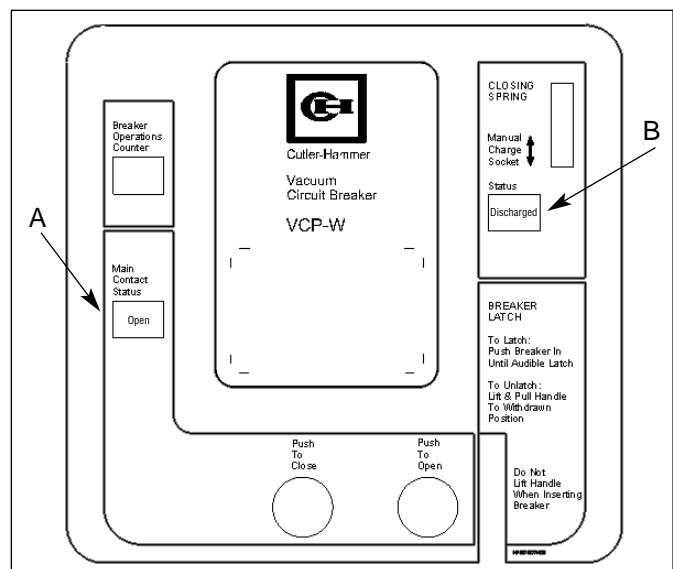

Figure 6-5 Status Indicators (“A” shows the contact status indication and “B” shows the spring indication.)

CAN RESULT FROM CONTACT WITH ENERGIZED EQUIPMENT. ALWAYS VERIFY THAT NO VOLTAGE IS PRESENT BEFORE PROCEEDING WITH THE TASK, AND ALWAYS FOLLOW GENERALLY ACCEPTED SAFETY PROCEDURES.

Safety Precautions: Read and understand these instructions before attempting any maintenance, repair or testing on the breaker. The user is cautioned to observe all recommendations, warnings and cautions relating to the safety of personnel and equipment.

The recommendations and information contained herein are based on Cutler-Hammer experience and judgment, but should not be considered to be all-inclusive or covering every application or circumstance which may arise. If further information is required, you should consult Cutler-Hammer.

Testing Procedures: Assuming that the breaker is safely pulled out to the Test/Disconnect position in the enclosure or placed on the workbench, follow this procedure to perform the CloSure™ Test. For further instructions on disconnecting the circuit breaker consult Section 4 of this manual. If the enclosure is equipped with the MOC operating in the test position also, make certain that the MOC is connected to operate.

Step 1 - On the front cover identify the status indicators. **MAKE SURE THE CLOSING SPRING STATUS INDICATES “Discharged” AND THE MAIN CONTACT INDICATOR SHOWS “Open”** (Figure 6-5).

Step 2 - Remove the circuit breaker front cover. **Be sure to save the original fasteners for reassembly.**

Step 3 - Cut a piece of one inch wide drafting/masking tape approximately 8 to 10 inches long.



Figure 6-6 Starting Tape at Bottom of Cam



Figure 6-7 Wrapping Tape Up Around Cam

Step 4 - Place the tape around the cam starting from the bottom up. Make certain that the tape adheres well to the cam surface. (See Figures 6-6, 6-7 and 6-8).



Figure 6-8 Attaching Tape Around to Back of Cam



Figure 6-9 Attaching CloSure™ Test Tool at Hole “A”

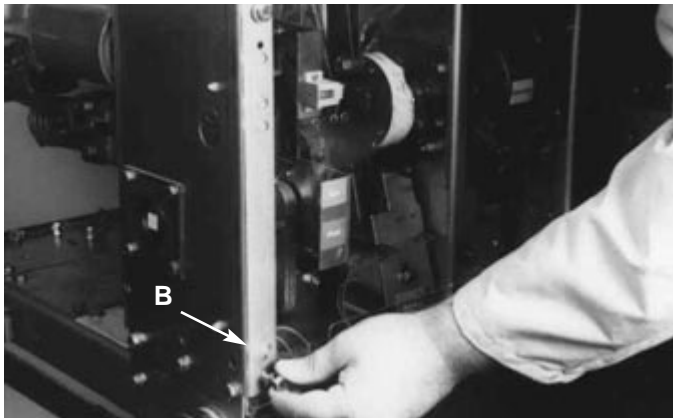

Figure 6-10 Attaching CloSure™ Test Tool at HP

Step 5 - Mount the transparent CloSure™ Test Tool with two bolts and washers. Refer to Figures 6-19, 6-20 and Table 6.4 for appropriate mounting holes. Hand tighten the bolts (Figures 6-9, 6-10, 6-19 and 6-20).

Step 6 - A Sanford® Sharpie® black fine point permanent marker, item no. 30001, is recommended for this next step. Place the marker tip in the proper hole ("C"). Refer to Figure 6-19 and make a heavy mark on the tape as shown in Figure 6-10.

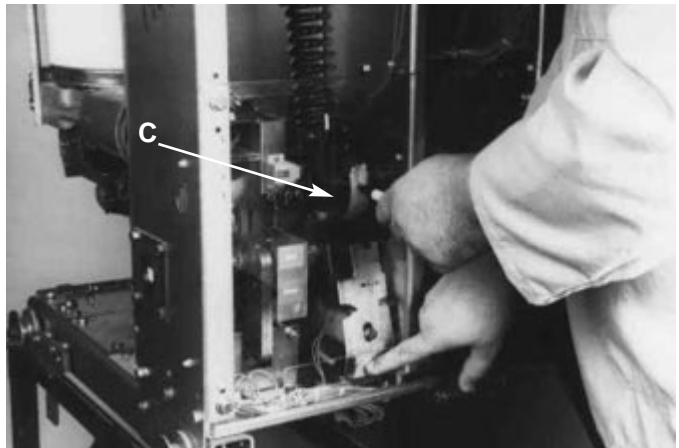

Figure 6-12 Manually Closing Circuit Breaker with Marker in Hole "C".

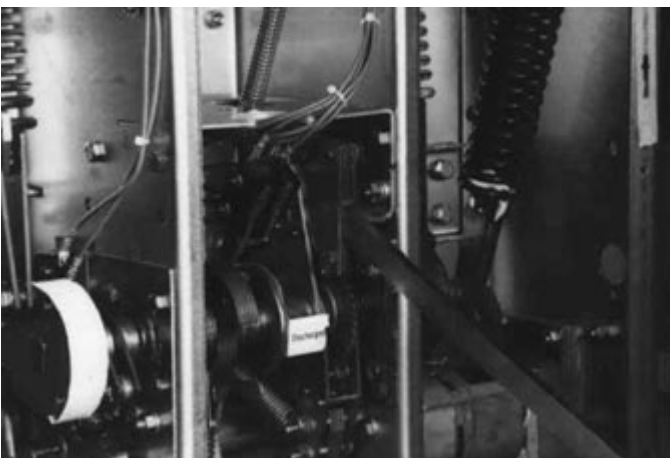

Figure 6-11 Manually Charging Closing Springs

Step 7 - Charge the closing springs with the maintenance tool. Continue charging the closing springs until a "click" is heard and the status indicator shows "Charged" (Figure 6-11).

Step 8 - While holding the marker tip on the tape, close the breaker (Figure 6-12).

Step 9 - Move the marker back and forth horizontally approximately 15° in both directions to create a line on

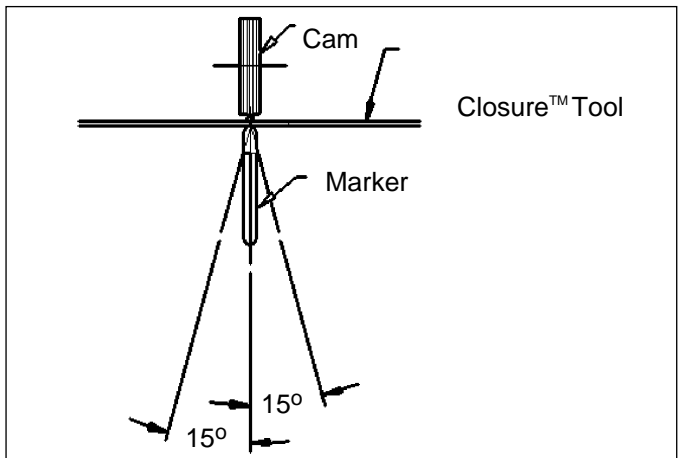

Figure 6-13 Top View of Cam and Marker Interface

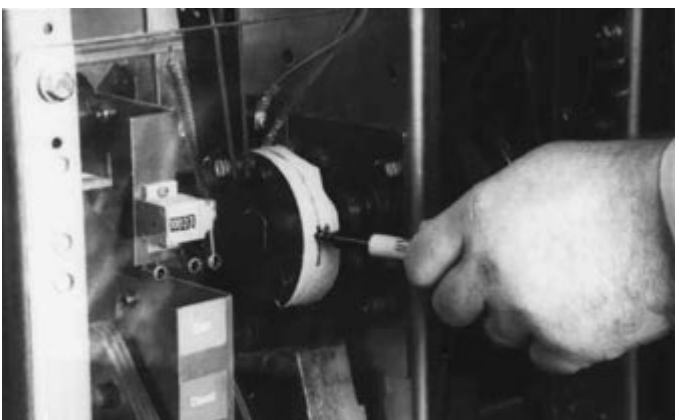

Figure 6-14 Move Marker 15° to Right

the tape that identifies the closed rest position (Figures 6-13, 6-19 and 6-15).



Figure 6-15 Move Marker 15° to Left



Figure 6-16 Remove Marked Masking Tape from Cam



Figure 6-17 Place Tape on Right Side Panel of Breaker

Step 10 - Remove the marker from hole "C".

Step 11 - Push the "push to open" clapper to open the circuit breaker.

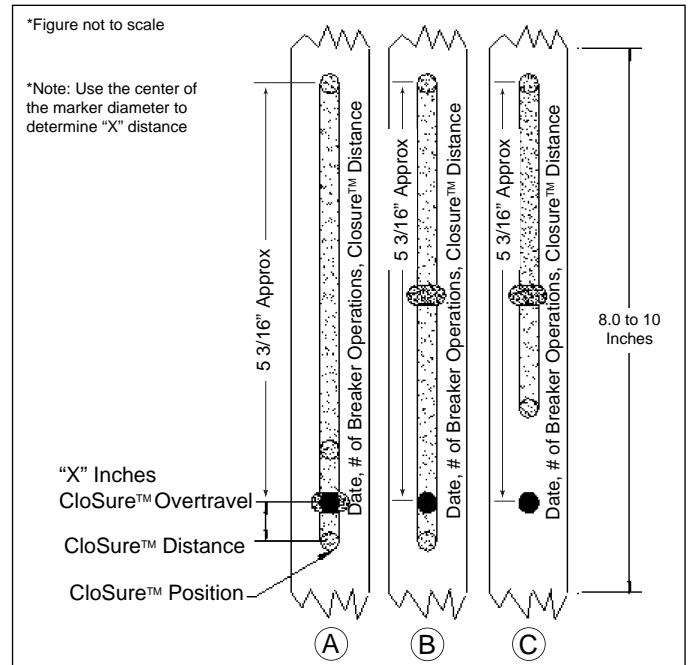

Figure 6-18 Illustrative Testing Tape Sample

Step 12 - Inspect the circuit breaker to assure it is in the open position and the closing springs are discharged. Remove the transparent CloSure™ Tool. Remove the tape from the cam and stick the tape on the front right side sheet of the circuit breaker. Record the date of the test and the operations counter reading on the tape (Figures 6-16 and 6-17 and 6-18).

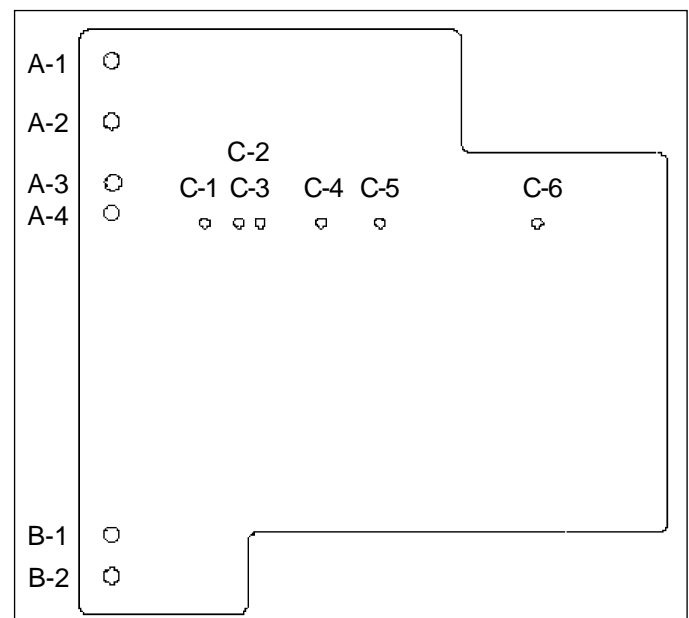

Figure 6-19 Front View of CloSure™ Tool Showing Mounting/Testing Hole Locations (6352C49H01)

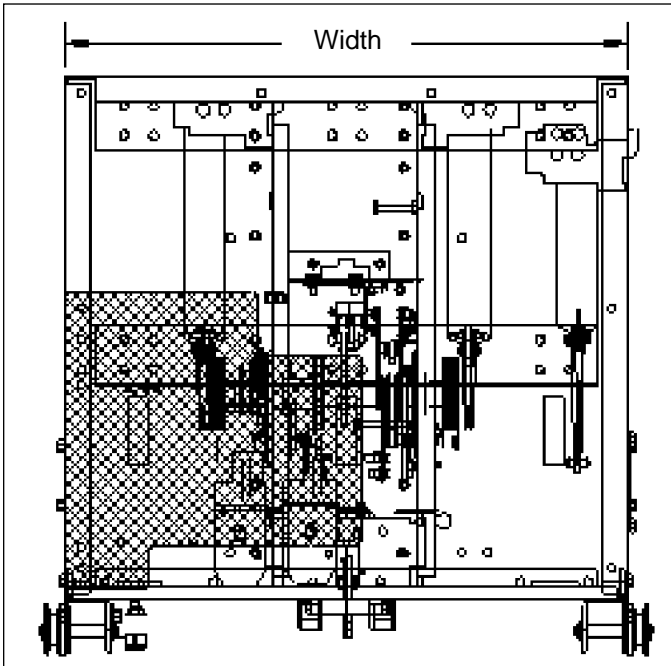

Figure 6-20 Typical Circuit Breaker Front View with CloSure™ Tool Attached (approximate mechanism chassis width)

Breaker Line	Approximate Mechanism Cabinet Width (inch)	Upper Mounting Hole	Lower Mounting Hole	Marker Placement Hole
DHP-VR	20	A1	B2	C2
	29	A1	B1	C5
VCPW-ND	20/21	A1	B2	C2
VCP-W	29	A1	B2	C5
	33	A2	B2	C6
VCP-WG, VCP-WGR	29	A1	B2	C5
VCP-WR	18	A1	B2	C1
	20	A1	B2	C2
	29	A1	B2	C5
W-VAC, W-VACR	18	A1	B2	C1
	25	A1	B1	C4
	33	A2	B2	C6

Table 6.4 Closure™ Tool Mounting/Testing Locations by Circuit Breaker Type

Step 13 - Evaluate the CloSure™ performance by comparing the test tape with the illustrations in Figure 6-18. If the marking is similar to 6-18A, measure the over travel “x”: If “x” is greater than or equal to 0.6 inches, the circuit breaker performance is satisfactory. If “x” is less than 0.6 inches or if the marking is similar to 6-18B or 6-18C, immediately contact the Product Integrity Center for Technical Support at (412) 787-6518.

Step 14 - Remove the CloSure™ Tool. Reassemble the front cover onto the circuit breaker. Return the circuit breaker to its original configuration and setup.

6-10 LUBRICATION

All parts that require lubrication have been lubricated during the assembly with molybdenum disulphide grease (Cutler-Hammer Material No. 53701QB). Over a period of time, this lubricant may be pushed out of the way or degrade. Proper lubrication at regular intervals is essential for maintaining the reliable performance of the mechanism. Once a year or every 500 operations whichever comes first, the circuit breaker should be

relubricated. The locations shown in Figure 6-1 should be lubricated with a drop of mineral oil.

After lubrication, operate the circuit breaker several times manually and electrically.

Roller bearings are used on the pole shaft, the cam shaft, the main link and the motor eccentric. These bearings are packed at the factory with a top grade slow oxidizing grease which normally should be effective for many years. They should not be disturbed unless there is definite evidence of sluggishness, dirt or parts are dismantled for some reason.

If it becomes necessary to disassemble the mechanism, the bearings and related parts should be thoroughly cleaned. Remove old grease in a good grease solvent. Do not use carbon tetrachloride. They should then be washed in light machine oil until the cleaner is removed. After the oil has been drawn off, the bearings should be packed with Cutler-Hammer Grease 53701QB or equivalent.

6-11 TROUBLESHOOTING CHART (Continued Next Page)

SYMPTOM	INSPECTION AREA	PROBABLE DEFECTS
<ul style="list-style-type: none"> • Closing Springs not charged 	<ul style="list-style-type: none"> • Control Circuit 	<ul style="list-style-type: none"> • Control Power (fuse blown or switch off) • Secondary Disconnects • Motor Cut-off Switch (Poor or burned contacts, Lever not operational) • Terminals and connectors (Poor or burned contacts) • Motor (Brushes worn or commutator segment open)
	<ul style="list-style-type: none"> • Mechanism 	<ul style="list-style-type: none"> • Pawls (Slipping or Broken) • Ratchet Wheel (Teeth worn or broken) • Cam Shaft Assembly (Sluggish or jammed) • Oscillator (Reset spring off or broken)
<ul style="list-style-type: none"> • Closing Spring charged but breaker does not close 	<ul style="list-style-type: none"> • No Closing Sound (Close Coil does not pick up) 	<ul style="list-style-type: none"> • Control Power (Fuse blown or switch off) • Secondary Disconnects • Anti-Pump Relay (Y relay N. C. contact open or burned or relay picks up) • Close Coil (Open or burned) • Latch Check Switch (Contact open-bad switch or trip bar not reset) • Auxiliary Switch (b contact open or burned) • Motor Cut-off (Contacts open or burned) • Trip Coil Assembly (Clapper fails to reset)

6-11 TROUBLESHOOTING CHART (Continued Next Page)

SYMPTOM	INSPECTION AREA	PROBABLE DEFECTS
Fails To Close		
	<ul style="list-style-type: none"> • Closing Sound but no close 	<ul style="list-style-type: none"> • Pole Shaft (Not open fully) • Trip Latch Reset Spring (Damaged or Missing) • Trip Bar-D Shaft (Fails to remain reset) • Trip Latch-Hatchet (Fails to remain reset) • Trip Floor Tripper (Fails to remain reset) • Close Latch (Binding) • Close Latch Roller (Binding) • Trip Circuit Energized
Undesirably Closes		
	<ul style="list-style-type: none"> • Control Circuit 	<ul style="list-style-type: none"> • Close Circuit (CS/C Getting Shorted)
	<ul style="list-style-type: none"> • Mechanism 	<ul style="list-style-type: none"> • Close Release Latch (Fails to reset) • Close Floor Tripper (Fails to reset)
Fails To Trip		
<ul style="list-style-type: none"> • No Trip Sound 	<ul style="list-style-type: none"> • Control Circuit 	<ul style="list-style-type: none"> • Control Power (Fuse blown or switch off) • Secondary Disconnect • Auxiliary Switch (a contact not making, poor or burned) • Trip Coil (Burned or open) • Terminals and Connections (Poor or burned or open)
	<ul style="list-style-type: none"> • Trip Mechanism 	<ul style="list-style-type: none"> • Trip Clapper (Jammed)

6-11 TROUBLESHOOTING CHART

SYMPTOM	INSPECTION AREA	PROBABLE DEFECTS
<p>Fails To Trip</p> <ul style="list-style-type: none"> • Trip Sound But No Trip 	<ul style="list-style-type: none"> • Trip Mechanism 	<ul style="list-style-type: none"> • Trip Bar, Trip Latch (Jammed) • Pole Shaft (Jammed) • Operating Rod Assembly (Broken or pins out)
	<ul style="list-style-type: none"> • Vacuum Interrupter (One or more Welded) 	
<p>Undesirably Trips</p>	<ul style="list-style-type: none"> • Control Circuit 	<ul style="list-style-type: none"> • Control Power (CS/T Switch, remains made)
	<ul style="list-style-type: none"> • Mechanism 	<ul style="list-style-type: none"> • Trip Coil Clapper (Not resetting) • Trip Bar or Trip Latch (Poor engagement of mating or worn surfaces) • Trip Bar Reset Spring (Loss of torque)

SECTION 7: RENEWAL PARTS

7-1.1 ORDERING INSTRUCTIONS

7-1 GENERAL

In order to minimize production downtime, it is recommended that an adequate quantity of spare parts be carried in stock. The quantity will vary from customer to customer, depending upon the service severity and continuity requirements. Each customer should develop his own stock level based on operating experience. Refer to Tables 7.1 and 7.2 for guidance.

- a. Always specify the breaker rating information and shop order number.
- b. Describe the item, give the style number, and specify the quantity required.
- c. Specify the voltage for electrical components.
- d. Specify the method of shipping desired
- e. Send all orders or correspondence to the nearest Cutler-Hammer sales office.

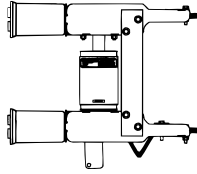
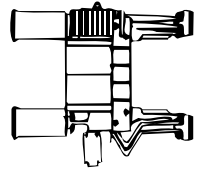
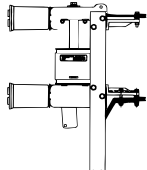
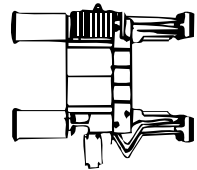
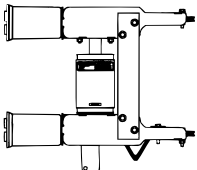

7.1 Recommended Renewal Parts for ANSI Rated Breakers (Continued Next Page)

Line No.	Description	Style Number			Qty.	
		VCP-W	VCPW-SE & 27kV	VCPW-ND		
1	<u>Interrupter Assembly</u>					
1A	50/250, 1200A-58kA	8297A02H01	8297A02H02	8297A02H03	3	
2	50/250, 1200A-58kA (4" SC)	8297A02H21	8297A02H22		3	
3	50/250H, 1200A-78kA	8297A05H01	8297A05H02		3	
3A	50/250, 2000A-58kA	8297A03H01	8297A03H02		3	
4	50/250, 2000A-58kA (5" SC)	8297A03H21	8297A03H22		3	
4	50/250H, 2000A-78kA	8297A06H01	8297A06H02		3	
5	50/250, 3000A-58kA	8297A04H01	8297A04H02		3	
6	50/250H, 3000A-78kA	8297A07H01	8297A07H02		3	
7	50/350, 1200A-78kA	8297A08H01	8297A08H02		3	
7A	50/350, 1200A-78kA (5" SC)	8297A08H21	8297A08H22		3	
7B	50/350C, 1200A-78kA	8297A08H23	8297A08H24		3	
8	50/350, 2000A-78kA	8297A09H01	8297A09H02		3	
8A	50/350, 2000A-78kA (5" SC)	8297A09H21	8297A09H22		3	
8B	50/350C, 2000A-78kA	8297A09H23	8297A09H24		3	
9	50/350, 3000A-78kA	8297A10H01	8297A10H02		3	
9A	50/63, 1200A	8297A29H05			3	
9B	50/63, 2000A	8297A30H05			3	
9C	50/63, 3000A	8297A31H03			3	
9D	50VCP-W40C, 3000A		8297A10H23		3	
9E	50VCP-W50C, 3000A		8297A10H23		3	
10	75/500, 1200A-66kA (5")	8297A11H01	8297A11H02		3	
10A	75/500, 1200A-66kA (4")	8297A11H03	8297A11H04		3	
11	75/500, 2000A-66kA	8297A12H01	8297A12H02		3	
11A	50VCP-WC, 1200A		8297A11H23		3	
11B	50VCP-WC, 2000A		8297A12H23		3	

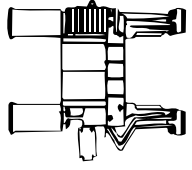
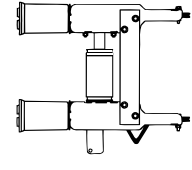
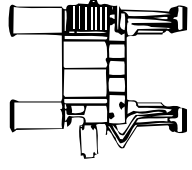
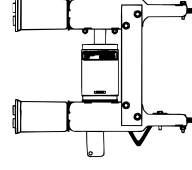
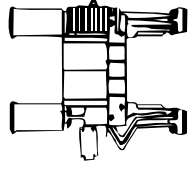
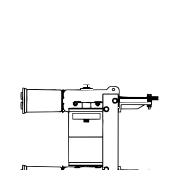
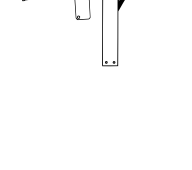



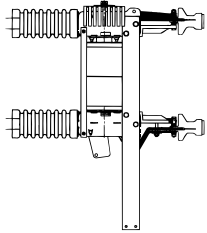
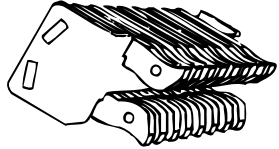
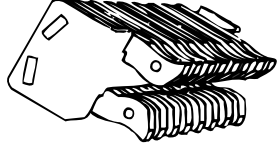
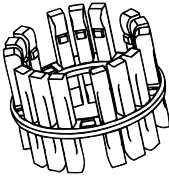

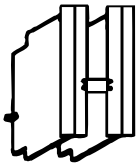
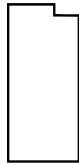

7.1 Recommended Renewal Parts for ANSI Rated Breakers (Continued Next Page)

Line No.	Description	Style Number		Qty.	
		VCP-W	VCPW-SE & 27kV		
12 12A	75/500, 3000A-66kA 75VCP-W50C, 3000A	8297A13H01	8297A13H02 8297A13H23	3 3	
13 13A 14 15 16 16A	150/500, 1200A-37kA (4") 150/500, 1200A-37kA (3" SC) 150/500H, 1200A-58kA 150/500, 2000A-37kA 150/500H, 2000A-58kA 150VCP-W25C, 1200A	8297A17H01 8297A17H21 8297A20H01 8297A18H01 8297A21H01	8297A17H02 8297A17H22 8297A20H02 8297A18H02 8297A21H02 8297A20H23	3 3 3 3 3 3	
17 18	150/500, 3000A-37kA 150/500H, 3000A-58kA	8297A19H01 8297A22H01	8297A19H02 8297A22H02	3 3	
19 20 21 22	150/750, 1200A-58kA 150/750H, 1200A-77kA 150/750, 2000A-58kA 150/750H, 2000A-77kA	8297A23H01 8297A26H01 8297A24H01 8297A27H01	8297A23H02 8297A26H02 8297A24H02 8297A27H02	3 3 3 3	
23 24	150/750, 3000A-58kA 150/750H, 3000A-77kA	8297A25H01 8297A28H01	8297A25H02 8297A28H02	3 3	
25 25A 25B 25C 26 26A 26B 26C 26D 26E 26F 26G	150/1000, 1200A-77kA (7") 150/1000, 1200A-77kA (5") 150/1000, 1200A-77kA (5")LT 150/1000C, 1200A-77kA (5")LT 150/1000, 2000A-77kA (7") 150/1000, 2000A-77kA (5") 150/1000, 2000A-77kA (5")LT 150/1000C, 2000A-77kA (5")LT 150VCP-W40C, 1200A 150VCP-W40C, 2000A 150VCP-W50C, 1200A 150VCP-W50C, 2000A	8297A29H01 8297A29H03 8297A29H21 8297A29H23 8297A30H01 8297A30H03 8297A30H21 8297A30H23	8297A29H02 8297A29H04 8297A29H22 8297A29H24 8297A30H02 8297A30H04 8297A30H22 8297A30H24 8297A29H36 8297A30H36 8297A29H37 8297A30H37	3 3 3 3 3 3 3 3 3 3 3 3	
27 27A 27B 27C	150/1000, 3000A-77kA 150/63, 1200A 150/63, 2000A 150/63, 3000A	8297A31H01 8297A29H31 8297A30H31 8297A31H31	8297A31H02	3 3 3 3	



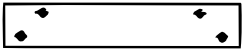

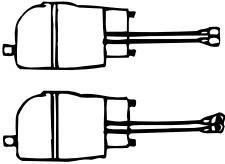
7.1 Recommended Renewal Parts for ANSI Rated Breakers (Continued Next Page)

Line No.	Description	Style Number			Qty.	
		VCP-W	VCPW-SE & 27kV	VCPW-ND		
28	270/25, 630A-37kA		8299A04H01		3	
29	270/25, 1200A-37kA		8299A05H01		3	
29A	270/25, 2000A-37kA		8299A02H01		3	
29B	270/32, 1200A-50kA		8299A05H21		3	
29C	270/32, 2000A-50kA		8299A02H21		3	
29D	270/40, 1200A-64kA		8299A05H31		3	
29E	270/40, 2000A-64kA		8299A02H31		3	
30	<u>Primary Disconnects</u> Up to 15kV, 1200A	508B022G01	508B022G01	502A851G02	6	
31	Up to 15kV, 2000A	508B012G01	508B012G01		6	
32	Up to 15kV 3000A	692C037G01	692C037G01		6	
32A	All 63kA	692C037G01	692C037G01		6	
33	27kV 630A		699B352G01		6	
34	27kV 1200A		699B352G01		6	
34A	27kV 2000A		502A852G02		6	
35	<u>Phase Barrier Kits</u> (2 Barriers per Kit) Up to 15kV			(4) Barriers		
	Interphase Barriers 2000A Outside Barriers 1200/2000A	694C549G03 694C549G06	694C549G03 694C549G06	694C622G03 694C622G03	1 1	

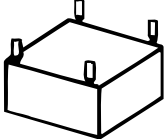
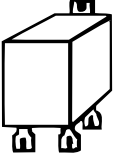

7.1 Recommended Renewal Parts for ANSI Rated Breakers (Continued Next Page)

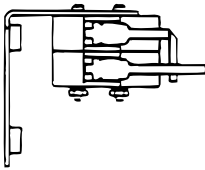
Line No.	Description	Style Number			Qty.	
		VCP-W	VCPW-SE & 27kV	VCPW-ND		
36	Up to 15kV, All 50/350, 150/1000, 150/63 and 3000A Breakers	691C648G01	691C648G01		1	
37	27kV		691C218H01		2	
38	<u>Push Rod Assemblies</u> Up to 15kV - White Springs	691C650G01	691C650G02		3	
39 39A 39B	Up to 15kV - Blue Springs Up to 15kV - Red Springs 150/63 - Orange Springs	691C651G01 691C651G03 1C94385G01	691C651G02 691C651G04 (for SE only) 1C94385G02	692C799G01	3 3 3	
40 40A	27kV - Blue Springs 27kV - Black Springs		691C241G01 1C94715G01		3 3	
41 41A	<u>Tie Bars</u> Up to 15kV 63kA only	3619A09H01 1C94404H01	691C271H01	3619A09H01	6 6	
42 42A	27kV (Up to 25kA) 27kV (31.5/40kA)		691C223H01 1C94707H01		6 6	
43 44 45	<u>Charging Motor</u> 48VDC 125VDC/120VAC 250VDC/240VAC	699B196G03 699B196G01 699B196G02	699B196G06 699B196G04 699B196G05	699B196G03 699B196G01 699B196G02	1 1 1	
46	Motor Brush Kit	8063A77G01	8063A77G01	8063A77G01	1	

7.1 Recommended Renewal Parts for ANSI Rated Breakers (Continued Next Page)

Line No.	Description	Style Number			Qty.	
		VCP-W	VCPW-SE & 27kV	VCPW-ND		
47	<u>Spring Release Coils</u> 48VDC	3759A76G01	3759A76G11	3759A76G01	1	
48		3759A76G02	3759A76G12	3759A76G02	1	
49		3759A76G03	3759A76G13	3759A76G03	1	
50	Rectifier (120/240VAC)	3759A79G01	3759A79G02	3759A79G01	1	
51	<u>Anti Pump (Y) Relay</u> 48VDC	3759A74G03	8237A27H03	3759A74G03	1	
52		3759A74G04	8237A27H04	3759A74G04	1	
53		3759A74G05	8237A27H05	3759A74G05	1	
54		3759A74G01	8237A27H01	3759A74G01	1	
55		3759A74G02	8237A27H02	3759A74G02	1	
56	<u>Shunt Trip Coils</u> 24VDC	3759A76G04	3759A76G14	3759A76G04	1	
57		3759A76G01	3759A76G11	3759A76G01	1	
58		3759A76G02	3759A76G12	3759A76G02	1	
59		3759A76G03	3759A76G13	3759A76G03	1	
60	<u>UV Trip Coils</u> 48VDC	8064A19G01	8064A19G01	8064A19G01	1	
61		8064A19G02	8064A19G02	8064A19G02	1	
62		8064A19G03	8064A19G03	8064A19G03	1	
62A		8064A19G09	8064A19G09	8064A19G09	1	
62B		8064A19G10	8064A19G10	8064A19G10	1	
63	Motor Cut Off Switch	699B199G01	699B199G04	699B199G01	1	
64	Latch Check Switch	699B147G01	699B147H04	699B147G01	1	

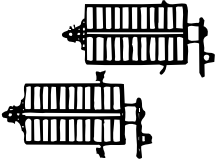
7.1 Recommended Renewal Parts for ANSI Rated Breakers (Continued Next Page)

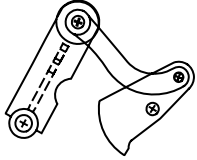
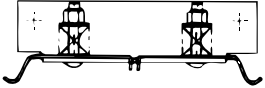
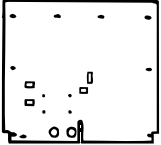
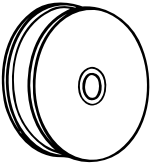
Line No.	Description	Style Number			Qty.	
		VCP-W	VCPW-SE & 27kV	VCPW-ND		
65 65A	Position Switch 1 Position Switch 2	8064A03G01 3759A93G01	699B147H01 3759A93H02	8064A03G01 3759A93G01	1 1	
66	Auxiliary Switch	698B822H01	5697B02G01	5697B02G02	1	
67	<i>Trip D-Shaft</i>	694C638G01	694C638G01	694C638G01	1	
68	Main Link & Trip Latch	3A75675G01	3A75675G01	3A75675G01	1	
69	Ground Contact Assy.	691C506G01	691C506G01	691C506G02		
70 71 72	<i>Front Panel (w/o ESCN)</i> 3000A, 350/1000 MVA, 63kA 27kV All Others	691C655H01 691C192H02	691C655H01 691C214H01 691C192H02	691C253H01		
73	Breaker Wheel	3617A99H02	3617A99H02	8237A50H01		

7.1 Recommended Renewal Parts for ANSI Rated Breakers

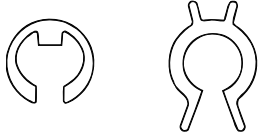
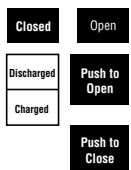
Line No.	Description	Style Number			Qty.	
		VCP-W	VCPW-SE & 27kV	VCPW-ND		
74	Fastener Kit	8061A01G01	8061A01G01	8061A01G01	1	
75	Labels Kit	8295A45G01	8295A45G01	8295A45G01	1	
76	Wiring Harness Repair Kit Complete Replacement	691C281G01 691C281G03 691C281G04	691C281G01 691C281G07 (SE) 691C281G05 (27kV) 691C281G08 (SE) 691C281G06 (27kV)	691C281G02 691C281G09 691C281G10		<p>} STANDARD & UV</p> <p>} WITH SHUNT TRIP 2</p>
77	UV Trip Kit 48VDC 125VDC 250VDC 120VAC 240VAC	691C274G01 691C274G02 691C274G03 691C274G04 691C274G05	691C274G01 691C274G02 691C274G03 691C274G04 691C274G05	691C274G01 691C274G02 691C274G03 691C274G04 691C274G05		
78	CloSure Test	6352C58G01	6352C58G01	6352C58G01		

7.1 Recommended Renewal Parts for ANSI Rated Breakers (Continued Next Page)

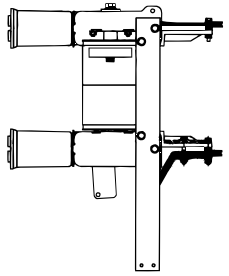
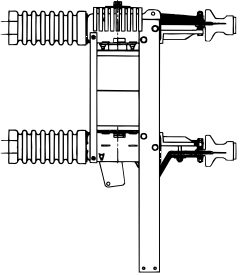
Line No.	Description	Style Number	Qty.	Typical View
		VCP-WC		
<i>Interrupter Assembly</i>				
101	50/25C, 1200A	8297A33H01	3	
102	50/25C, 2000A	8297A33H02	3	
103	50/25C, 3000A	8297A33H03	3	
104	50/40C, 1200A	8297A34H01	3	
105	50/40C, 2000A	8297A34H02	3	
106	50/40C, 3000A	8297A34H03	3	
107	50/50C, 1200A	8297A34H04	3	
108	50/50C, 2000A	8297A34H05	3	
109	50/50C, 3000A	8297A34H06	3	
110	50/63C, 1200A	8297A35H01	3	
111	50/63C, 2000A	8297A35H02	3	
112	50/63C, 3000A	8297A35H03	3	
113	75/50C, 1200A	8297A34H07	3	
114	75/50C, 2000A	8297A34H08	3	
115	75/50C, 3000A	8297A34H09	3	
116	150/25C, 1200A	8297A33H11	3	
117	150/25C, 2000A	8297A33H12	3	
118	150/25C, 3000A	8297A33H13	3	
119	150/40C, 1200A	8297A34H11	3	
120	150/40C, 2000A	8297A34H12	3	
121	150/40C, 3000A	8297A34H13	3	
122	150/50C, 1200A	8297A34H14	3	
123	150/50C, 2000A	8297A34H15	3	
124	150/50C, 3000A	8297A34H16	3	
125	150/63C, 1200A	8297A35H11	3	
126	150/63C, 2000A	8297A35H12	3	
127	150/63C, 3000A	8297A35H13	3	
128	270/25C, 1200A	8297A36H01	3	
129	270/25C, 1600A	8297A36H02	3	
130	270/32C, 1200A	8297A36H03	3	
131	270/32C, 1600A	8297A36H04	3	
132	270/40C, 1200A	8297A36H05	3	
133	270/40C, 1600A	8297A36H06	3	

7.1 Recommended Renewal Parts for ANSI Rated Breakers

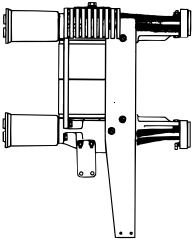
Line No.	Description	Style Number	Qty.	Typical View
		VCP-WG		
<i>Interrupter Assembly</i>				
134	50WG50, 1200A	8297A32H01	3	
135	50WG50, 2000A	8297A32H02	3	
136	50/WG50, 3000A	8297A32H03	3	
137	50WG63, 1200A	8297A32H04	3	
138	50WG63, 2000A	8297A32H05	3	
139	50/WG63, 3000A	8297A32H06	3	
140	150WG50, 1200A	8297A32H11	3	
141	150WG50, 2000A	8297A32H12	3	
142	150/WG50, 3000A	8297A32H13	3	
143	150WG63, 1200A	8297A32H14	3	
144	150WG63, 2000A	8297A32H15	3	
145	150/WG63, 3000A	8297A32H16	3	

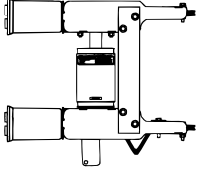
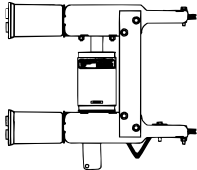
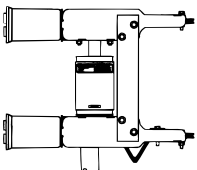
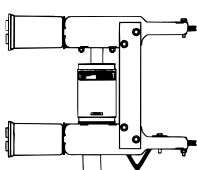
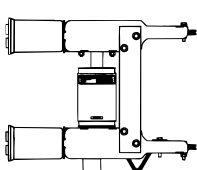
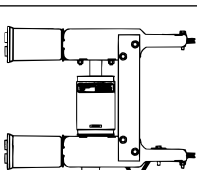
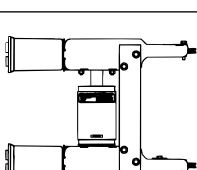

7.2 Recommended Renewal Parts for IEC Rated Breakers (Continued Next Page)

Line No.	Description	Style Number		Qty.	
		Up to 17.5kV	24kV		
1 2 3	<i>Interrupter Assembly</i> 36/25-630A 36/25-1250A 36/25-2000A	8299A01H01 8299A01H02 8299A01H03		3 3 3	
4 5	36/32-1250A 36/32-2000A	8299A01H04 8299A01H05		3 3	
6 7	36/40-1250A 36/40-2000A	8299A01H06 8299A01H07		3 3	
8 9 10	72/25-630A 72/25-1250A 72/25-2000A	8299A01H08 8299A01H09 8299A01H10		3 3 3	
11 12	72/32-1250A 72/32-2000A	8299A01H11 8299A01H12		3 3	
13 14	72/40-1250A 72/40-2000A	8299A01H13 8299A01H14		3 3	
15 16 17	120/25-630A 120/25-1250A 120/25-2000A	8299A01H15 8299A01H16 8299A01H17		3 3 3	

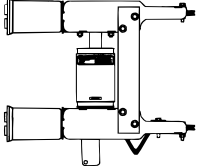
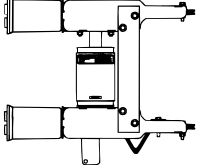
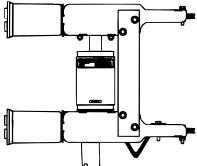
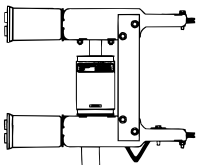
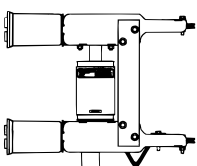
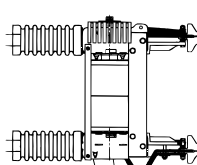
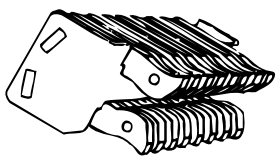

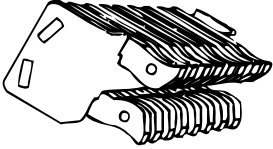
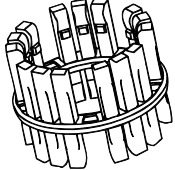
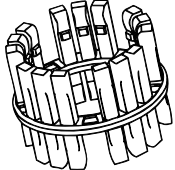
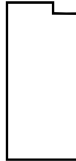

7.2 Recommended Renewal Parts for IEC Rated Breakers (Continued Next Page)

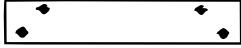
Line No.	Description	Style Number		Qty.	
		Up to 17.5kV	24kV		
18 19	120/32-1250A 120/32-2000A	8299A01H18 8299A01H19		3 3	
20 21	120/40-1250A 120/40-2000A	8299A01H20 8299A01H21		3 3	
22 23	175/25-1250A 175/25-2000A	8299A01H22 8299A01H23		3 3	
24 25	175/32-1250A 175/32-2000A	8299A01H24 8299A01H25		3 3	
26 27	175/40-1250A 175/40-2000A	8299A01H26 8299A01H27		3 3	
28 29 29A	240/25-630A 240/25-1250A 240/25-2000A		8299A01H28 8299A01H29 8299A01H30	3 3 3	
30 31	<i>Primary Disconnects</i> Up to 175/40-630A Up to 175/40-1250A	699B104G01 508B022G01		6 6	

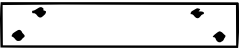
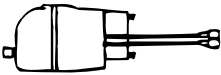

7.2 Recommended Renewal Parts for IEC Rated Breakers (Continued Next Page)

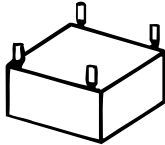
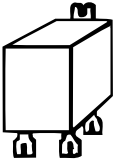
Line No.	Description	Style Number		Qty.	
		Up to 17.5kV	24kV		
32	Up to 175/40-2000A	508B012G01		6	
33	240/25-630A		699B352G01	6	
34 34A	240/25-1250A 240/25-2000A		699B352G01 502A852G02	6 6	
35 37	<i>Phase Barriers</i> Up to 175/40 240/25	691C176H01	691C218H01	2	
38 39	<i>Push Rod Assemblies</i> Up to 175/40 - White Springs Up to 175/40 - Blue Springs	691C650G01 691C651G01		3 3	
40	240/25		691C241G01	3	
41	<i>Tie Bars</i> Up to 175/40	3619A09H01		6	

7.2 Recommended Renewal Parts for IEC Rated Breakers (Continued Next Page)

Line No.	Description	Style Number		Qty.	
		Up to 17.5kV	24kV		
42	<u>Tie Bars</u> 240/25		691C223H01	6	
43	<u>Charging Motor</u> 48VDC	699B196G03	699B196G06	1	
44	125VDC/120VAC	699B196G01	699B196G04	1	
45	250VDC/240VAC	699B196G02	699B196G05	1	
46	Motor Brush Kit	8063A77G01	8063A77G01	1	
47	<u>Spring Release Coils</u> 48VDC	3759A76G01	3759A76G11	1	
48	125VDC/120VAC	3759A76G02	3759A76G12	1	
49	250VDC/240VAC	3759A76G03	3759A76G13	1	
50	Rectifier (120/240VAC)	3759A79G01	3759A79G02	1	
51	<u>Anti Pump (Y) Relay</u> 48VDC	3759A74G03	8237A27H03	1	
52	125VDC	3759A74G04	8237A27H04	1	
53	250VDC	3759A74G05	8237A27H05	1	
54	120VAC	3759A74G01	8237A27H01	1	
55	240VAC	3759A74G02	8237A27H02	1	
56	<u>Shunt Trip Coils</u> 24VDC	3759A76G04	3759A76G14	1	
57	48VDC	3759A76G01	3759A76G11	1	
58	125VDC/120VAC Cap Trip	3759A76G02	3759A76G12	1	
59	250VDC/240VAC Cap Trip	3759A76G03	3759A76G13	1	

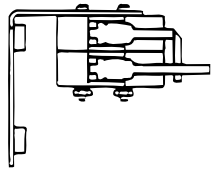
7.2 Recommended Renewal Parts for IEC Rated Breakers (Continued Next Page)

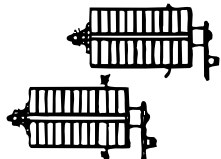
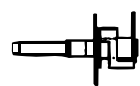
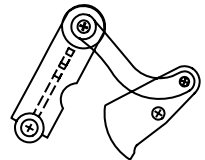
Line No.	Description	Style Number		Qty.	
		Up to 17.5kV	24kV		
60	<u>UV Trip Coils</u> 48VDC	8064A19G01	8064A19G01	1	
61	125VDC	8064A19G02	8064A19G02	1	
62	250VDC	8064A19G03	8064A19G03	1	
62A	120AC	8064A19G09	8064A19G07	1	
62B	240AC	8064A19G08	8064A19G08	1	
63	Motor Cut Off Switch	699B199G01	699B199G04	1	
64	Latch Check Switch	699B147G01	699B147H04	1	
65	Position Switch 1	8064A03G01	699B147H01	1	
65A	Position Switch 2	3759A93G01	3759A93H02	1	
66	Auxiliary Switch	698B822H01	5697B02G01	1	
67	<u>Trip D-Shaft</u>	694C638G01	694C638G01	1	
68	Main Link & Trip Latch	3A75675G01	3A75675G01	1	

7.2 Recommended Renewal Parts for IEC Rated Breakers

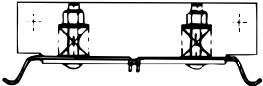
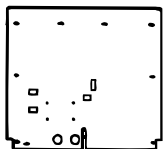
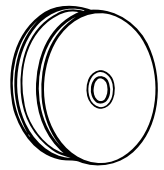
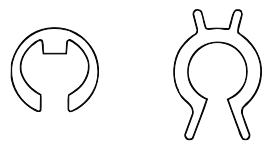
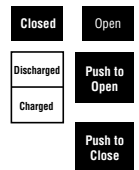
Line No.	Description	Style Number		Qty.	
		Up to 17.5kV	24kV		
69	Ground Contact Assembly	691C506G01	691C506G01		
70 71	<i>Front Panel (w/o ESCN)</i> 240/25 All Others	691C192H02	691C214H01		
73	Breaker Wheel	3617A99H01	3617A99H01		
74	Fastener Kit	8061A01G01	8061A01G01		
75	Labels Kit	8295A45G01	8295A45G01	1	
76	Wiring Harness Repair Kit Complete Replacement	691C281G01 691C281G03 691C281G04	691C281G01 691C281G05 691C281G06		STANDARD & UV WITH SHUNT TRIP 2
77	UV Trip Kit 48VDC 125VDC 250VDC 120VAC 240VAC	691C274G01 691C274G02 691C274G03 691C274G04 691C274G05	691C274G01 691C274G02 691C274G03 691C274G04 691C274G05		
78	CloSure Test	6352C58G01	6352C58G01		

This instruction booklet is published solely for information purposes and should not be considered all inclusive. If further information is required, you should consult Cutler-Hammer.

Sale of product shown in this literature is subject to terms and conditions outlined in appropriate Cutler-Hammer selling policies or other contractual agreement between the parties. This literature is not intended to and does not enlarge or add to any such contract. The sole source governing the rights and remedies of any purchaser of this equipment is the contract between the purchaser and Cutler-Hammer.

NO WARRANTIES, EXPRESSED OR IMPLIED, INCLUDING WARRANTIES OF FITNESS FOR A PARTICULAR PURPOSE OR MERCHANTABILITY, OR WARRANTIES ARISING FROM COURSE OF DEALING OR USAGE OF TRADE, ARE MADE REGARDING THE INFORMATION, RECOMMENDATIONS AND DESCRIPTIONS CONTAINED HEREIN. In no event will Cutler-Hammer be responsible to the purchaser or user in contract, in tort (including negligence), strict liability or otherwise for any special, indirect, incidental or consequential damage or loss whatsoever, including but not limited to damage or loss of use of equipment, plant or power system, cost of capital, loss of power, additional expenses in the use of existing power facilities, or claims against the purchaser or user by its customers resulting from the use of the information, recommendations and description contained herein.

Cutler-Hammer

Pittsburgh, PA

Effective 12/02 (ISI)
Style 32-255-1G
Printed in U.S.A.

EAT•N